

HP 4195A
Network/Spectrum Analyzer
User's Guide

TABLE OF CONTENTS

Chapter 1	Operating the HP 4195A Function Keys PRESET Connections Controls Calibration Measurement Enhancements
Chapter 2	Transmission Measurements with the HP 4195A Insertion Loss (Gain) 3 dB Bandwidth Out-of Band Rejection Passband Ripple Group delay Gain Compression
Chapter 3	Reflection Measurements with the HP 4195A Return Loss, Reflection Coefficient, SWR S-parameters Impedance (Smith Chart)
Chapter 4	Spectrum Measurement with the HP 4195A Level Measurement Noise Level Harmonic Distortion Multi-Point Spectrum Measurement
Chapter 5	Impedance Measurement with the HP 4195A Equivalent Circuit Parameter Calculation Frequency Characteristics Simulation
APPENDIX A	Internal Registers
APPENDIX B	User Program Examples: Alternate Transmission/Reflection Measurement, SIN/COS waves Display, 3dB Bandwidth, THD, Go/No-Go Testing with Limit Line
APPENDIX C	User Defined Function Examples: Filter Parameters, Singal Track, Alternate Sweep, 4-ch Spectrum Measurement
APPENDIX D	User Math Function Examples: Max Hold, Averaging, 75 Ω Measurement, Vp-p Measurement
APPENDIX E	Softkey Tree
APPENDIX F	Internal Registers/Command Listing

Chapter 1

Operating the HP 4195A

Function Keys

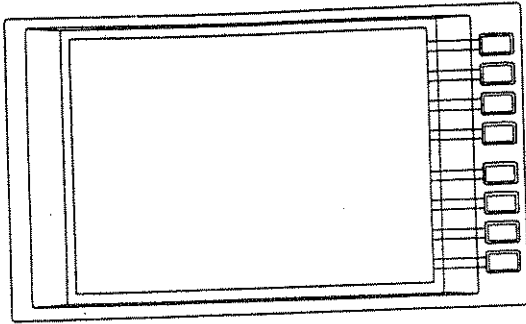

A simple and easy to use set of keys and softkeys, make using the HP 4195A for measurement and analysis an easy task. When a key is pressed, the related set of softkeys are displayed, and when a softkey is pressed, an additional set of related softkeys may be displayed (the softkeys are arranged in a tree format) depending on the function selected. Consequently, operation is made easier by the reduced number of front panel keys, and by the context sensitive displayed set of softkeys. The keys are grouped by function, Measure, Sweep, Marker/Line-Cursor, etc. The softkeys are displayed by pressing the appropriate key in the related function key group. The following is a summary of the HP 4195A's primary functions and their related keys.

To Prepare for a Measurement

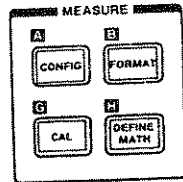

- Network/Spectrum/Impedance/S-parameter selection (**CONFIG**)
- S11/S21/S12/S22 selection (**CONFIG**)
- Input Port selection (**CONFIG**)
- Display parameters, T/R- θ , T/R- τ , $|\Gamma|$ - θ , SWR, dB μ V, dBm/Hz selection (**FORMAT**)
- Normalize, 1-port partial CAL, 1-port full CAL selection (**CAL**)
- User math definition, ON/OFF (**DEFINE MATH**)

To Modify the Display Scale

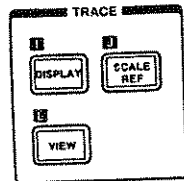

- Rectangular/Smith/Polar/Table selection (**DISPLAY**)
- COMMENT, Phase Expand (**DISPLAY**)
- Autoscale, Log Scale (**SCALE REF**)
- Superimpose, Storage (**VIEW**)
- Trace A/B ON/OFF (**DISPLAY**)
- Trace C/D ON/OFF (**VIEW**)

To Modify a Sweep

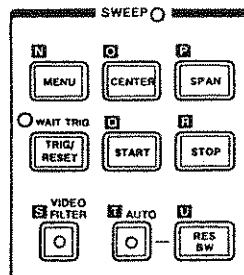

- Frequency/DC Bias/Power Sweep selection (**MENU**)
- SPOT frequency entry (**MENU**)
- Lin/Log Sweep selection (**MENU**)
- Partial Sweep/Program Sweep (**MENU**)
- Continuous/Single/Manual Sweep selection (**MENU** or **TRIG/RESET**)
- **TRIG/RESET** key initiates a sweep when the WAIT TRIG lamp is on while in the SINGLE sweep mode. In the CONT sweep mode pressing the **TRIG/RESET** key re-starts the sweep.
- **VIDEO FILTER** performs four time averaging.

To Enter Data

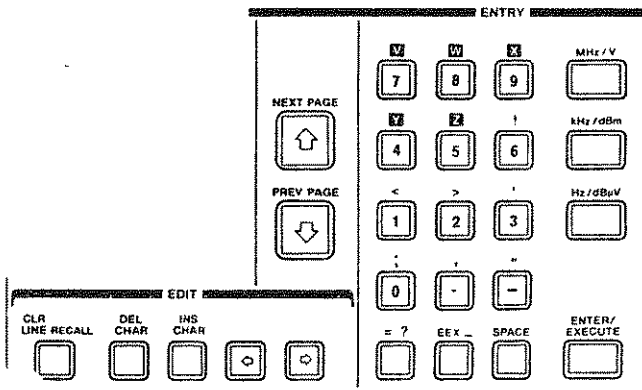

Frequency, Resolution Bandwidth, and Input attenuator are set with the \uparrow and \downarrow keys or the numeric entry keys. When data is entered using the numeric entry keys, the **ENTER**, **MHz/V** or other unit keys must be used to terminate the entry.

To Use the Markers

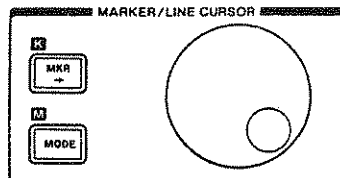

- MKR→MAX, MKR→CENTER, MKR→REF, MKR→SPAN, NEXT PEAK (**MKR→**)
- Single Marker, Dual Marker, Cursor, Cursor with Marker selection (**MODE**)
- Noise Marker (**MODE**)

To Extend Functions

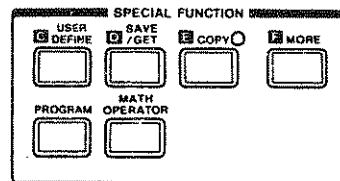

- User Defined Function (**USER DEFINE**)
- CATALOG, SAVE, GET, PURGE (**SAVE/GET**)
- PLOT, PRINT, DUMP (**COPY**)
- TALK ONLY, HP-IB Address (**COPY** or **MORE**)
- Impedance Equivalent Circuit Analysis (**MORE**)
- Partial Analysis (**MORE**)
- User Program edit/execution (**PROGRAM**)
- +, *, /, (,) selection (**MATH OPERATOR**)
- SIN, COS, LOG, LN, SQR, MAX, MIN, complex, selection (**MATH OPERATOR**)

Blue key and Green key

- Blue key enables shiftkey operations while the blue key is set to on.
- Green key enables only single shiftkey operation after the green key is pressed.

General Measurement Sequence

With simple, easy, operation procedures, the HP 4195A can perform many types of measurement and analysis. The following basic operation sequence is common to all functions.

- | | |
|--------------------------|--|
| CONFIG | Press the CONFIG key to select between network, spectrum, impedance and S-parameter. |
| PRESET | Initialize the HP 4195A |
| CONNECTIONS | Connect the required accessories to the HP 4195A. |
| CONTROLS | Set up the HP 4195A as follows. <ol style="list-style-type: none">1. Press the FORMAT key to select dBm, dBμV, V and other measurement parameters.2. Press DISPLAY key to select displayed format. (RECT, TABLE, SMITH, POLAR)3. Press the SWEEP keys to set frequency range. (START, STOP, CENTER, SPAN). |
| CALIBRATE | Remove errors that can affect the quantity of the measurement. |
| DEVICE UNDER TEST | Connect the device under test (DUT). |
| AUTOSCALE | Optimize display setting. |

Step 1: CONFIG

```

NETWORK
A:REF      E:REF      MKR 250 000 000.000 Hz
0.000     100.0     T/R
[ dB ] [ deg ] [ deg ]
SPECTRUM
IMPEDANCE
S-PRMTR
menu
PORT
SELECT
DIV      DIV      START      0.001 Hz
10.00   35.00   STOP 500 000 000.000 Hz
RBW:300 Hz ST:1.15 sec RANGE:F= 10, F= 10dBm

```

Select network, spectrum, impedance or S-parameter measurement function. Press **CONFIG** key for this selection.

Step 2: PRESET

When the **PRESET** key is pressed, the HP 4195A is initialized for network, spectrum, impedance or S-parameter measurements.

Initialization using the PRESET key

MEASURE group

FORMAT T/R(dB)- θ (network/S21/S12)
 dBm (spectrum)
 |Z| - θ (impedance)
 RL - θ (S11/S22)

PORT R1 (spectrum)
 T1/R1 (network/impedance/S11)
 T2/R1 (S21), T1/R2 (S12), T2/R2 (S22)

TRACE group

DISPLAY rectan X-A&B
 SCALE REF REF= 0 dB, 10 dB/div (network)
 REF= 0 dBm, 10 dB/div (spectrum)

SWEEP group

Sweep mode CONT (SINGLE in program)
 Sweep type LIN Sweep
 Parameter FREQ Sweep
 Range 0.001 Hz ~ 500 MHz, sweep of 401 points
 RBW AUTO, 300 kHz

Measurement unit (lower box)

Source amplitude 0 dBm
 Atten 20 dB
 DC Bias OFF

Settings not affected by the PRESET key

- CONFIG (Network/Spectrum/Impedance/S-parameter)
- User math function and user defined function settings
- User Program
- Data stored in the registers (except A and B)

Step 3: CONNECTIONS

The HP 4195A has two output and four input terminals which can be configured to perform different measurements. The following accessories are used with the hp 4195A.

Transmission Measurements

Power splitter or Transmission/Reflection Test set

Reflection Measurements

Transmission/Reflection Test Set

Spectrum Measurements

No special equipment required

Direct Impedance Measurements

HP 41951A Impedance Measurement Kit

S-parameter Measurements

Two Transmission/Reflection Test Sets

The following examples use one HP 41952A Transmission/Reflection Test Set, two HP 41952A Transmission/Reflection Test Sets, and the HP 41951A Impedance Measurement Kit.

HP 41952A Transmission/Reflection Test Set

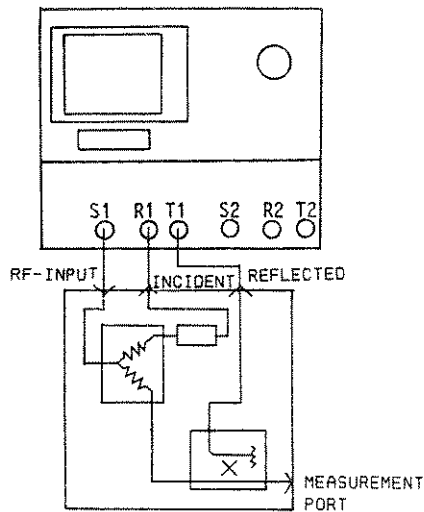

HP 41952A/B
TRANSMISSION
/REFLECTION
TEST SET

Power splitters are normally used for transmission measurements. However, if reflection measurements are also performed, the HP 41952A Transmission/Reflection Test Set should be used.

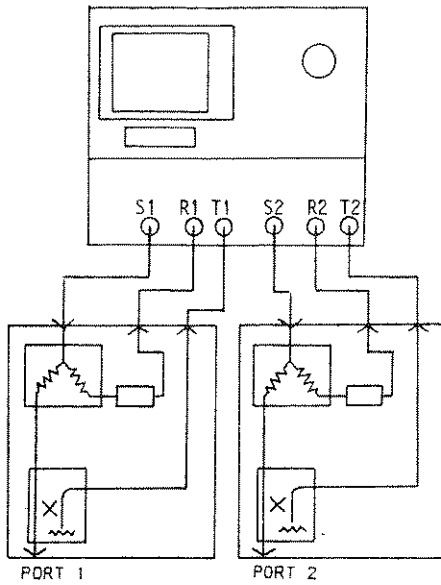

HP 41952A/B TRANSMISSION
/REFLECTION TEST SETS

When two HP 41952A Transmission/Reflection Test Sets are used, the DUT's forward and reverse transmission and reflection factors can be measured. These measurements are made without disconnecting and changing the direction of the DUT, making S-parameter measurement is an easy process.

**HP 41951A
Impedance Measurement Kit**

Connect the HP 41951A Impedance Measurement Kit to the HP 4195A as shown in the figure. The 4195A can be used to measure impedance directly when used with the HP 41951A.

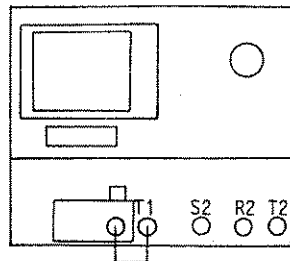

HP 41951A
IMPEDANCE
TEST KIT

Step 4: CONTROLS

1. FORMAT

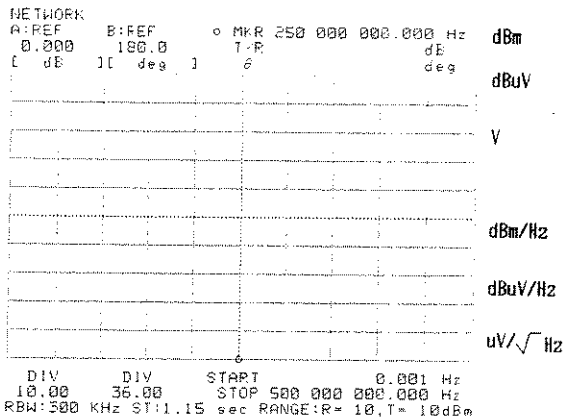

Select the display measurement parameters. When the **FORMAT** key is pressed, softkeys like those shown in the example to the left will be displayed. The softkeys displayed upon the screen depends on the existing setting. Select the required measurement parameters.

2. DISPLAY

Select displayed format from RECT, TABLE, SMITH and POLAR. When rectan A-B is selected, horizontal axis represents measured data A and vertical axis represents measured data B.

3. SWEEP

Select the measurement frequency range using the **CENTER** and **SPAN** keys, or by using **START** and **STOP** keys. The and keys are used to aid entry data. Note that the marker/cursor control knob cannot be used for this purpose.

Frequency, signal level, and DC bias level can be swept by selecting the proper softkey in the **SWEEP MENU**.

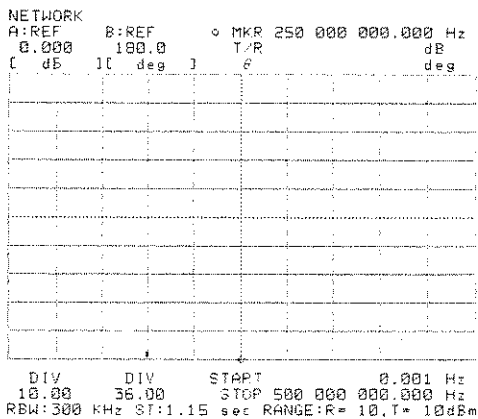

- TYPE
lin log — Select either linear or log sweep.
- DIRECTN
up down — Select the sweep direction.
- RESOLUTN
menu — Set the sweep points, steps, and time.
- PRMTR
menu — Select the sweep parameter - frequency, signal level, or DC bias.
- PROGRAM
sweep — Press this softkey to perform a programmed points sweep.
- PARTIAL
sweep — Press this softkey to perform a partial sweep.
- TRIGGER
menu — Press this softkey to select the trigger mode - CONT, SINGLE or MANUAL.

Step 5: CALIBRATE

In the case of high frequency network and impedance measurement, the cables and test sets will greatly affect the measurement results. To obtain the most accurate measurements, it is necessary to reduce the errors caused by the measurement system. The HP 4195A analyzer is equipped with a variety of calibration modes to meet different measurement requirements.

Transmission Measurement

Normalize
Normalize + Isolation

Reflection Measurement

Normalize (OPEN)
1-port Partial (OPEN, LOAD)
1-port Full (OPEN, SHORT, LOAD)

Impedance Measurements

Calibration (CAL: OPEN, SHORT, LOAD)
Compensation (COMPEN: 0S, 0 Ω)

Calibration is not allowed during spectrum measurement. However, when a high loss probe is used, the User Math Function should be used to compensate for the loss.

Typical calibration procedures for different types of measurement will be described next.

Calibration Standard

Any types of calibration standard can be used for calibration but their calibrated data must be entered correctly. For example, if a 7 mm OPEN standard is used, 0.108pF of its capacitance value should be entered using the following procedure.

NETWORK

```
CALIBRATION STANDARD DEFINITION
for NETWORK/S-PARA
OPEN : 0.00000 (S) +100.000f (F)
SHORT: 0.00000 (O) +0.00000n (H)
LOAD : 50.0000 (O) +0.00000n (H)
```

1. Press **CAL** key.
2. Press **more 1/2** softkey.
3. Press **CAL STD** modify softkey.
4. Press **OPEN CAL STD** softkey.
5. Type **OPENSTD=0, 108E-15** and press **ENTER**.

Use the same procedure to modify 0 Ω and 50 Ω standard values.

Transmission Measurement - Normalization

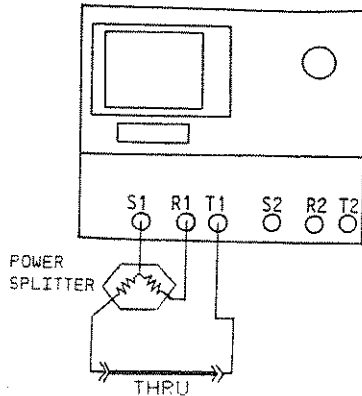

Normalization is an easy and commonly used calibration method. It eliminates transmission measurement errors. Make a "thru" connection to establish the 0 dB and 0 degree references as shown in the figure, then perform the following procedure.

1. Press the **CAL** key.
2. Press the **TRANS CAL** menu softkey.
3. Press the **NORMALIZE (THRU)** softkey.
4. Press the **THRU** softkey.
5. Press the **ENTER** key
6. Press the **return** softkey when the HP 4195A beeps and displays "THRU CAL completed".
7. Press the **CORRECTION on/off** softkey to enable correction (on/off).

After the preceding procedure is completed, the HP 4195A will display the measurement data normalized to the 0 dB and 0 degree reference established during the "Thru" calibration.

Normalization, however, does not eliminate errors such as leakage between a DUT's input and output. To eliminate such errors as this, perform the Isolation CAL in addition to the normalize CAL. To perform Isolation CAL, press the **NORM & ISN CAL** softkey instead of the **NORMALIZE (THRU)** softkey. To perform an "Isolation" CAL, disconnect the DUT and terminate the input/output terminal connected to the DUT with the correct characteristic impedance (50 Ω or 75 Ω).

Reflection Measurement - 1 port Full CAL

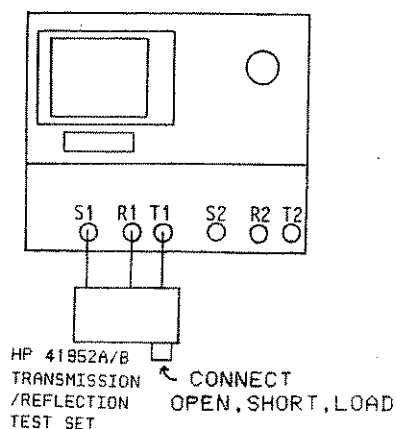

To perform 1-port Full CAL, three reference terminations: "OPEN", "SHORT" and "LOAD" are required. With reference to these three terminations connected one by one to the measurement terminal, the HP 4195A can minimize the errors in reflection measurements. The calibration procedure for the 1-port Full CAL is as follows.

1. Press the **CAL** key.
2. Press the **REFLECTN CAL** menu softkey.
3. Press the **ONE PORT FULL CAL** softkey.
4. Press the **OPEN** softkey.
5. Connect the "OPEN" termination to the measurement port and press the **ENTER** key.
6. Press the **SHORT** softkey.
7. Replace the "OPEN" termination with the "SHORT" termination and press the **ENTER** key.
8. Press the **LOAD** softkey.
9. Connect the "LOAD" termination (50Ω or 75Ω termination) and press the **ENTER** key.
10. Press the return softkey.
11. Press the **CORRECTION on/off** softkey to enable correction (on/off).

Now the HP 4195A is ready to make calibrated reflection measurements.

Other than 1-port Full CAL, the HP 4195A can perform 1-port Partial CAL, and Normalize CAL for calibrating reflection measurements. These two calibrations require fewer terminations to perform, but produce less accuracy than performing the 1-port Full CAL.

Two independent 1-port Full CALs can be performed. This allows S11 and S22 measurements to be performed without recalibrating.

Impedance Measurement - Calibration and Compensation

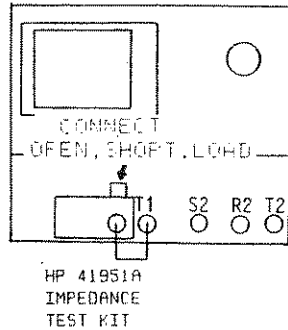

The HP 4195A and HP 41951A can be used to perform impedance measurements. A reflection coefficient measurement method is used when making impedance measurements. Therefore, the calibration procedure is almost the same as 1-port Full CAL and is performed as follows.

1. Press the **CAL** key.
2. Press the **CAL** menu softkey.
3. Press the **ONE PORT FULL CAL** softkey
4. Press the **OPEN** softkey.
5. Connect the **0S (OPEN)** termination to the 41951A's 7 mm connector and press the **ENTER** key.
6. Press the **SHORT** softkey.
7. Replace the **0S (OPEN)** termination with the **0Ω (SHORT)** termination and press the **ENTER** key.
8. Press the **LOAD** softkey
9. Connect the **50Ω (LOAD)** termination and press the **ENTER** key.
10. Press the **return** softkey.
11. Press the **CORRECTN on/off** to enable correction (on/off).

After the preceding procedure (**Calibration**) is performed, the HP 4195A will eliminate the measurement errors due to the HP 41951A Impedance Test Kit, and give the best impedance measurement accuracy at the 7 mm connector.

When a test fixture is connected to the 7 mm connector, error **COMPENSATION** for the test fixture is required. To compensate for fixture induced error, use the following procedure.

1. Press the **CAL** key.
2. Press the **COMPEN** menu softkey.
3. Press the **0S & 0Ω OFFSET** softkeys.
4. Press the **0S** softkey.
5. Connect the test fixture leaving its test terminal open, and press the **ENTER** key.
6. Press the **0Ω** softkey.

7. Short the test terminal of the test fixture, and press the **ENTER** key.
8. Press the return softkey.
9. Press the **CORRECTN on/off** softkey to enable correction (on/off).

NOTE Compensation must be performed after Calibration is completed.

Step 6: DUT

Connect the DUT (device under test) and perform the measurement.

Step 7: AUTO SCALE

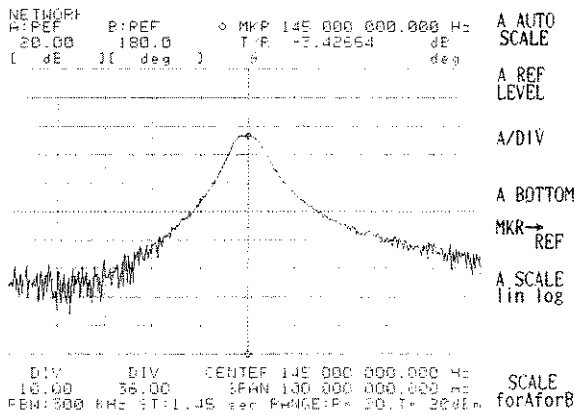

When the measurement results are too large or too small press the **SCALE REF** key to select the **AUTO SCALE** softkey (see figure). The scale of the display can be modified either by entering a new value with the **REF LEVEL** softkey the **/DIV** softkey, or by incrementing or decrementing the scale values using the \uparrow and \downarrow keys. This will adjust the scale of either trace A or B. Scale adjustment of the trace B display scale can be performed using the **SCALE for A/B** softkey.

Measurement Enhancements

The following functions enable the HP 4195A analyzer to be used more efficiently.

- Dynamic range
- Marker
- Recording of measurement data

The HP 4195A has many additional convenient functions. Refer to the APPENDIX and the HP 4195A's operation manual for the most complete description of the available functions.

Dynamic Range

The HP 4195A uses the following methods to improve its dynamic range (the difference between the maximum level of the input signal compared with the noise level).

1. Increasing Output Signal Level (Transmission Measurement Only)

The HP 4195A's signal level can be changed by entering a new value after pressing the **AMPLITUDE** key, or by using the \uparrow and \downarrow keys. The default value is 0.0 dBm, and can be increased to +15.0 dBm. This method is particularly effective with transmission/reflection test sets where the losses are high. Raising the signal level is equivalent to raising the input level and may cause waveform distortion. In this case, reduce the signal level so it does not exceed the allowable input value (RANGE value displayed on the CRT).

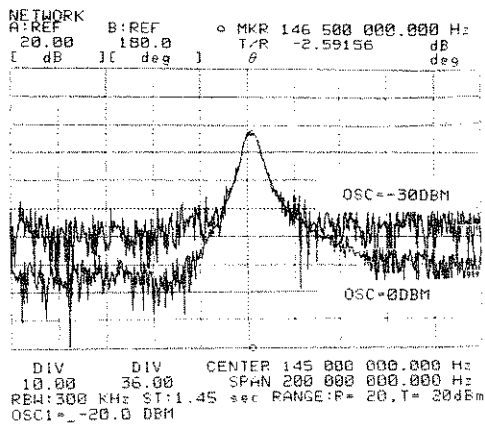

2. Changing the Input Attenuators

The input attenuators can be set by entering a new value after pressing the **REF ATTEN** or the **TEST ATTEN** keys, or by using the \uparrow and \downarrow keys. The 4195A's maximum allowable input level is the RANGE values displayed in the lower right corner of the CRT. For example, the figure shows RANGE values at the time when the R1 input attenuator is changed. These values mean that the maximum allowable input is +10 dBm for R1 and -20 dBm for T1.

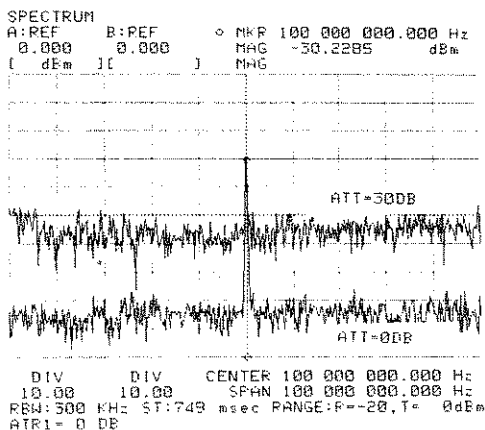

If the input level exceeds the allowable input range, the displayed waveform could be distorted.

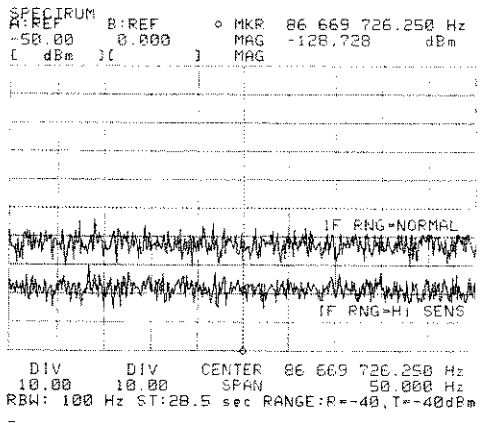

3. Changing the IF Range

The HP 4195A has 3 IF ranges - normal, low distortion, and high sensitivity - they are described below.

Normal Mode: This mode is normally used (default mode).

Low distortion Mode: This mode reduces distortion within the analyzer and is used for low distortion measurement.

High Sensitivity Mode: This mode reduces the internal noise of the analyzer, and is suitable for measurement of low level signals.

The IF range can be changed by pressing the **ATTEN** key and selecting the required softkey.

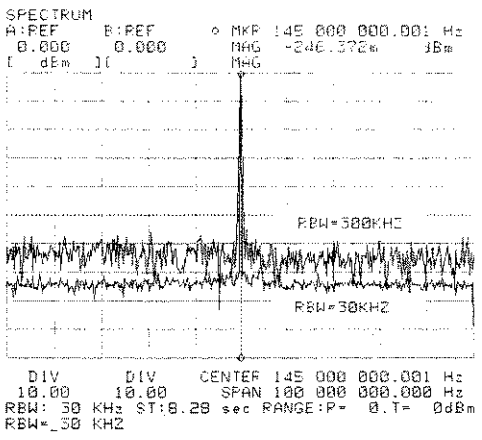

4. Narrowing the Resolution Bandwidth

The Resolution bandwidth (RBW) of the HP 4195A can be set in increments of 1 and 3 within the range of 3 Hz ~ 300 kHz. RBW can be set by entering a new value after pressing the **RES BW** key, or by pressing the \uparrow and \downarrow keys.

Note that the time increases as the dynamic range is increased by narrowing the IF bandwidth (i.e. lowering the value). When the **RES BW** is set to **AUTO**, the IF bandwidth is automatically set according to the frequency SPAN.

5. Using a Video Filter

When the **VIDEO FILTER** is set to **ON**, the measurement data is displayed after the average of four measurements is taken. This operation reduces random noise and improves the effective dynamic range.

The Marker

The marker functions of the HP 4195A help to reduce the time needed to make complicated measurements. The following describes the basic operation of the marker functions (refer to Chapter 2 and beyond for more information). One marker is initially displayed. The frequency and the measurement data at the marker's position are shown in the upper right corner of the display.

Press the **MKR→** key and the softkeys shown to the left will be displayed.

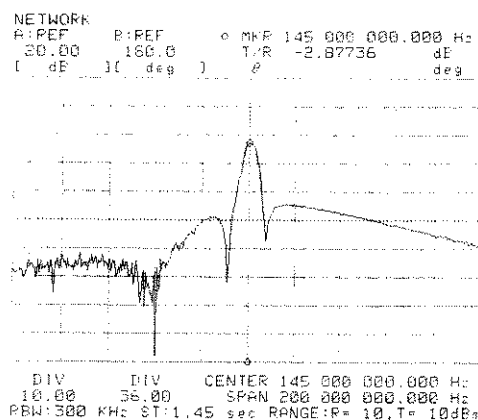

- MKR→ MAX — Moves the marker to the maximum value (peak) displayed.
- MKR→ MIN — Moves the marker to the minimum value displayed.
- MKR→ REF — Modifies the REF LEVEL value so that the marker is positioned at the reference level.
- MKR→ CENTER — Modifies the center value so that the marker is positioned at the center.
- NEXT PEAK — Moves the marker to the next highest peak.
- MKR forAforB more 1/2 — This makes it possible to use the marker on trace B.

"More" indicates that additional softkeys are available. These additional softkeys make it possible to use a marker's position as the START or STOP value, or to display the noise level at a marker's position.

When the **MODE** key is pressed the softkeys shown to the left will be displayed.

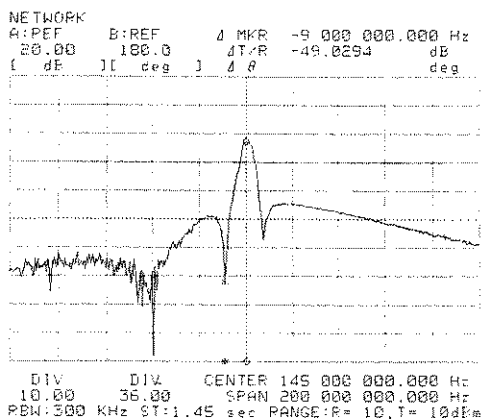

- Normal Marker Mode
- MKR — This causes an additional marker (*) - the sub-marker - to appear. It is used for zooming, partial sweep, partial analysis and deviation display (delta marker).
- MKRS
- LINE CURSOR — This causes the marker to toggle the cursor off/on the screen. The value of measurement data intersected by the cursor is displayed.
- MKR& LCURS
- off — This makes it possible to determine the cursor's position with reference to the marker position. This is convenient when searching for the -3 dB bandwidth.
- off — This turns the marker and cursor off. This function is used to reduce the measurement time.

Flexible Disc Drive (FDD)



The HP 4195A can save/recall the following files using its internal FDD.

- Instrument's setting state (**STATE file**)
User Defined Function keys, User Math Function and Calibration data are also included.
- Program Point Table (**TABLE file**)
- Measurement Data (**DATA file**)
- User Program (**ASP file**)

All files are recorded in LIF format. The figure below shows the screen after the **CAT** softkey is pressed.

FILE NAME	TYPE	SECTOR	FILE
VOLUME LABEL: HF4195			
AVAILABLE SECTOR 2289			
CN1	ASP		
CN2	ASP		
3DELEM	ASP		
SAWLISLIDB	ASP		
TRACFINIG	STATE		
ALT.SUN	ASP		
TRACE2	ASP		
THD1	ASP		
THD2	ASP		
4195A	STATE		
4195B	STATE		
HONDA_4195	ASP		
F1	DATA		
F1S	STATE		
FRONT_CVR	DATA		
CAL	ASP		

- CAT** — Displays disc content.
- SAVE** — Records instrument setup, measurement data or user program.
- RE-SAVE** — Rewrites an existing file and saves it.
- GET** — Reads a recorded file.
- PURGE** — Deletes files. RECOVER is used to recall files deleted by mistake.
- more** 2/2 — Used with RECOVER, and to format a disc.

When the **SAVE** and **RE-SAVE** softkeys are selected, softkeys which indicate the type of file to be saved are displayed: **STATE** (instrument setting), **PROG TABLE** (program point table), **DATA** (measurement data), and **PROGRAM** (User program). One of these keys must be selected. When the stored files cannot be displayed on the screen, use the  and  keys or the **NEXT PAGE** and **PREV PAGE** keys to see the other files that are not being displayed on the present screen. When the **GET**, **RE-SAVE** and **PURGE** keys are pressed, the file name at the top is displayed within " ". If a desired file is moved to the top, it is no longer necessary to press the alphabetic keys.

Recording Measurement Data

Measurement data can be recorded by printing/plotting the data or storing it on the HP 4195A's internal flexible disc drive (FDD).

Hard Copy

The HP 4195A's display data can be copied to a printer or HP-GL compatible plotter. When the COPY key is pressed, the softkeys shown in the figure below will be displayed. To produce a hard copy, the analyzer must be in the TALK ONLY mode and the printer or plotter must be in the LISTEN ONLY mode.

NETWORK
A:REF B:REF MKR 250 000 000.000 Hz
0.000 100.0 T/R dB deg deg
[dB] [deg]

COPY start }
COPY abort } Start or stop the hardcopy function.

PLOT mode — Outputs screen data to plotter.

PRINT mode }
DUMP mode } Outputs measurement data, program lists, and CAT to the printer.

HP-IB define — Used in the TALK ONLY mode.

PLOT menu — Specifies how data is to be sent to the plotter.

DIV DIV START 0.001 Hz
10.00 36.00 STOP 500 000 000.000 Hz
RBW:300 KHz ST:1.15 sec RANGE:R= 10, T= 10dBm

DUMP Procedure

Use the following procedure to dump the current display to an HP-IB printer.

1. Connect the HP-IB printer to the HP 4195A. The printer must be set to **LISTEN ONLY** or **LISTEN ALWAYS** mode.
2. Press HP-IB define softkey.
3. Press Talk Only softkey. TLK lamp will turn on.
4. Press return softkey.
5. Press DUMP mode softkey.
6. Press COPY start softkey.

Chapter 2

Transmission Measurements with the HP 4195A

Basic Setup

The following measurement examples use a power splitter or the HP 41952A Transmission/Reflection Test Set (directional bridge or other setup can be used to suit your particular needs). The DUT used in these examples is 145 MHz bandpass filter.

Measuring Insertion Loss (Gain)

CONFIG Press **CONFIG** key and select **NETWORK**

PRESET Press the **PRESET** key to set the analyzer to its initial state.

CONNECTIONS Set up the power splitter as shown in the figure.

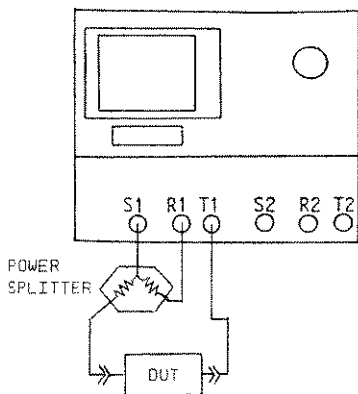

CONTROLS

1. **FORMAT** T/R (dB) - θ (Initial state)
2. **DISPLAY** Rectan X-A&B (Initial state)
3. **SWEEP** CENTER 145 MHz
SPAN 100 MHz

CALIBRATE

Perform the **normalization** calibration as described on page 1-10. Connect the output and the input cable to the DUT together to create a **thru** connection. Press the HP 4195A **CAL** key, select the **TRANS CAL** menu, and press the **NORMALIZE (THRU)** softkey. Then press the **THRU** softkey and the **ENTER/EXECUTE** key to perform normalization. After measuring a thru, press **CORRECTN on/off** softkey.

DEVICE UNDER TEST

Connect the DUT as shown in the figure, and press **TRIGGER** key to initiate a sweep.

AUTOSCALE

Press the **SCALE REF** key and select the **AUTO SCALE** softkey. The measurement result shown in the figure will then be displayed. The yellow trace (trace A) indicates the amplitude ratio of the two inputs (dB) and the light blue trace (trace B) indicates the phase difference (θ).

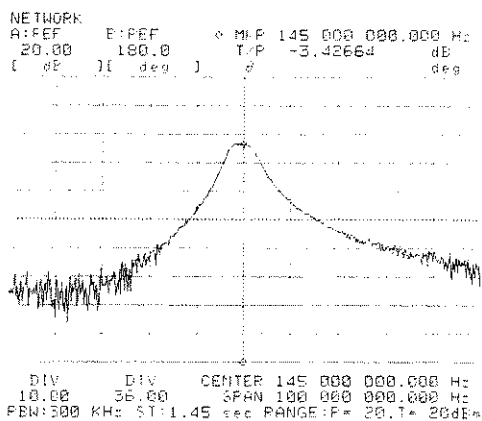

Insertion Loss

Use the **MKR→MAX** softkey to read the insertion loss at the frequency.

3 dB Bandwidth

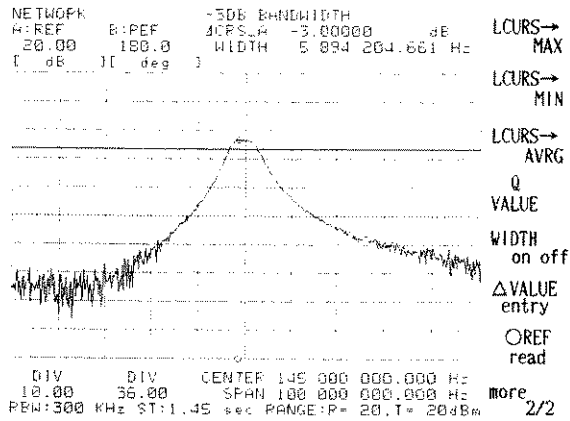

The bandwidth can easily be determined with the marker and line-cursor.

1. Press the **MODE** key and select the **oMKR&LCURS** softkey.
2. Press the **MKR→MAX** softkey.
3. Press the **Δ mode on/off** softkey.
4. Press the **more 1/2** softkey, then press the **Δ VALUE** entry softkey. **DLCURS=** will be displayed.
5. Enter **-3 dB**.
6. Set the **WIDTH on/off** softkey to **on/off**, the **-3 dB** bandwidth is displayed at **WIDTH** on the upper right corner of the screen.

Out-of-Band Rejection

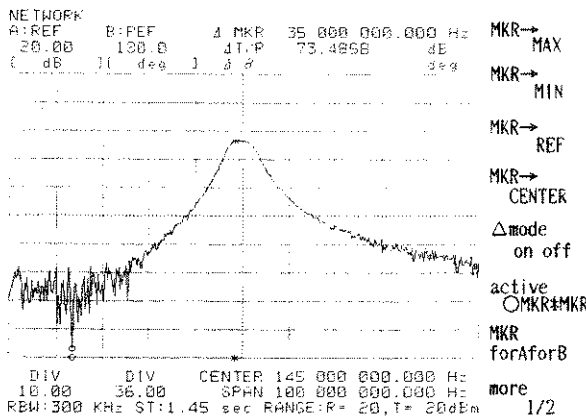

Use the double marker mode (**o&*MKRS**) to determine out-of-band rejection.

1. Press the **MODE** key and select the **o&*MKRS** softkey.
2. Press the **MKR→MAX** softkey. *** MKR** moves to the **MAX** position.
3. Set the **Δ mode on/off** softkey to **on/off** the difference between **o MKR** and *** MKR** will be displayed on the screen.
4. Press the active **oMKR/-MKR** softkey to make the **oMKR** active.
5. Press the **MKR→MIN** softkey and the **oMKR** will seek the point of greatest insertion loss. The **Δ T/R** shown here is the out-of-band rejection (**dB**).

Passband Ripple

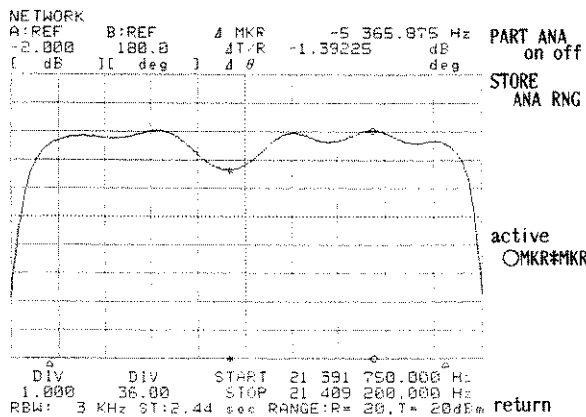

Passband ripple can be measured when a partial analysis function is used (The figure shows an example of a filter with ripple).

1. Enter the double marker mode (**o&*MKRS**) and alternately move the two markers to within the passband region with the rotary knob as shown in the figure to the left.
2. Press the **SPECIAL FUNCTION MORE** key, select the **ANA RANGE** softkey and the softkeys shown in the figure to the left will appear.
3. Press the **STORE ANA RNG** softkey, set the **PART ANA on/off** softkey to **ON (on/off)**, and the **Δ** symbols appear at the bottom of the screen. The area indicated by these symbols is subjected to the partial analysis.
4. Make the **o MKR** active, press the **MKR→MAX** softkey, make also *** MKR** active and perform **MKR→MIN**. When the **Δ mode** is set to **ON**, the magnitude of the ripple is displayed as **Δ T/R(dB)**.

Measuring Phase Characteristics

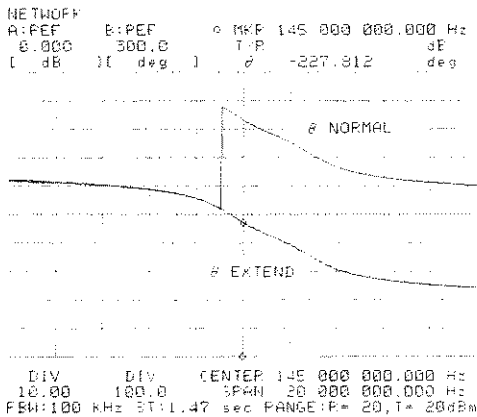

The HP 4195A's vector network measurement function makes it possible to measure phase characteristics at the same time as amplitude ratio measurements are performed. The phase measurement data is displayed on trace B. As shown in the figure to the left, trace B data can be phase extended to more than $\pm 180^\circ$. Also the phase unit can be changed to radians. In the next section we will measure group delay, important in determining phase distortion.

Group Delay Measurement

Group delay (τ) is defined as follows.

$$\tau = \frac{\Delta \theta \text{ (radian)}}{\Delta \omega} = \frac{\Delta \theta \text{ (}^\circ\text{)}}{360^\circ \cdot \Delta F}$$

ΔF is the frequency difference between the two frequencies and $\Delta \theta$ is the phase difference between the two frequencies. Thus the group delay is the degree of change in phase relative to a change in frequency. When the group delay is constant, the phase change is linear and there is no phase distortion. ΔF is called aperture and is expressed as a percentage of measurement frequency range (SPAN frequency).

CONFIG NETWORK

PRESET Press the **PRESET** key.

CONNECTIONS

Used the same connections used for measuring insertion loss.

CONTROLS

1. **FORMAT** Select T/R - τ
2. **DISPLAY** Rectan X-A&B (Initial state)
3. **Sweep** CENTER 145 MHz
SPAN 20 MHz

CALIBRATE

Setup the analyzer in thru connection and conduct a normalization calibration (same as insertion loss).

DEVICE UNDER TEST

Connect the DUT as shown in the figure to the left, and press the **TRIG/RST** key.

AUTOSCALE

Press the **SCALE REF** key, and select **SCALE** for A and B **AUTO SCALE** softkeys.

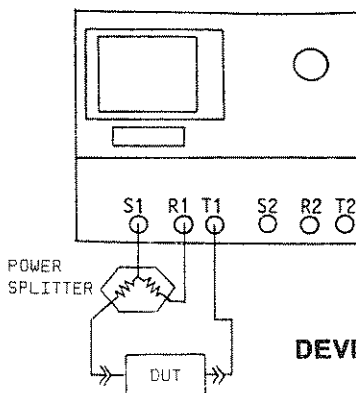

```

NETWORK
A:REF B:REF 0 MKR 144 500 000.000 Hz
10.00 400.0n T/R -4.16181 dB
[ dB ] [ sec ] z 151.502n sec

```

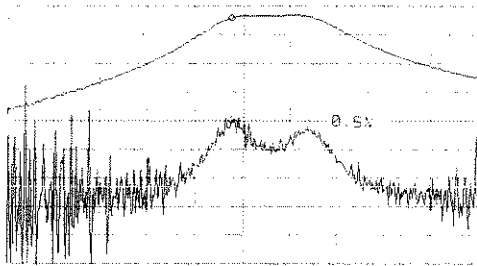

```

DIV DIV CENTER 145 000 000.000 Hz
10.00 50.00n SPAN 20 000 000.000 Hz
RBW:100 KHz ST:1.47 sec RANGE:R= 20,T= 20dBm
DFREQ= 0.50

```

The default aperture value for group delay measurements is 0.5% of the frequency span width. It can be changed up to maximum of 100%. To set the aperture, press the **FORMAT** key, select the **APERTURE** entry softkey. When **DFREQ =** is displayed, enter a value between 0.5 and 100.

The figure to the left shows the effect of different aperture settings on group delay measurements. The trace will gradually become smoother as the aperture span width is increased from 0.5%, to 1% and then 2%. The aperture setting must be made with care when group delay measurements are performed, because it influences the measurement values and the resolution. When the aperture is increased, measurement resolution increases, but the accuracy along the lateral axis (frequency) decreases. In group delay measurements it is necessary to know at which aperture a measurement value was obtained.

```

NETWORK
A:REF B:REF 0 MKR 144 500 000.000 Hz
10.00 400.0n T/R -4.15585 dB
[ dB ] [ sec ] z 140.410n sec

```

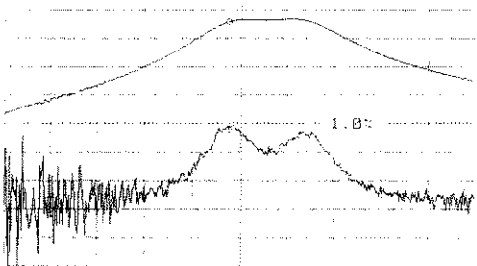

```

DIV DIV CENTER 145 000 000.000 Hz
10.00 50.00n SPAN 20 000 000.000 Hz
RBW:100 KHz ST:1.47 sec RANGE:R= 20,T= 20dBm
DFREQ= 1.00

```

```

NETWORK
A:REF B:REF 0 MKR 144 500 000.000 Hz
10.00 400.0n T/R -4.15846 dB
[ dB ] [ sec ] z 145.140n sec

```

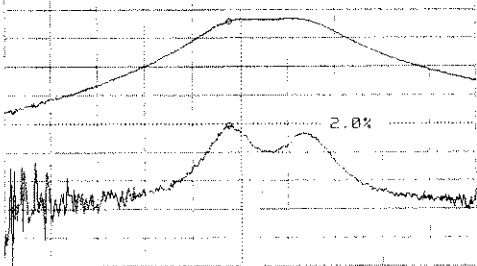

```

DIV DIV CENTER 145 000 000.000 Hz
10.00 50.00n SPAN 20 000 000.000 Hz
RBW:100 KHz ST:1.47 sec RANGE:R= 20,T= 20dBm
DFREQ= 2.00

```



Measuring Gain Compression

All measurements so far have been frequency swept measurements. However, signal source output (OSC level and DC bias can also be swept and measured with the H 4195A. In the following the OSC level will be swept to obtain the maximum input level at which the output level does not change linearly (Gain Compression).

CONFIG NETWORK

PRESET Press the **PRESET** key.

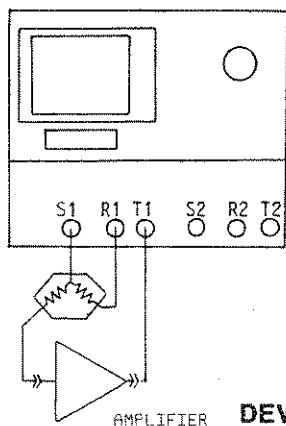
CONNECTIONS Set up as shown in the figure on the left.



CONTROLS

1. **FORMAT** T/R (dB) - θ (Initial State)
2. **DISPLAY** rectan X-A&B (Initial State)
3. **SWEEP** Press the **MENU** key and the **PRMTR** key
Select **OSC LVL** (dBm).
START -26 dBm
STOP 0 dBm

CALIBRATE

Make a thru connection and perform a normalization calibration as described in the first setup in this chapter (insertion loss measurements).

DEVICE UNDER TEST

Connect the DUT (amplifier) as shown in the figure on the left, and press **TRIG/RST** key.

AUTOSCALE

Press the **AUTO SCALE** softkey.

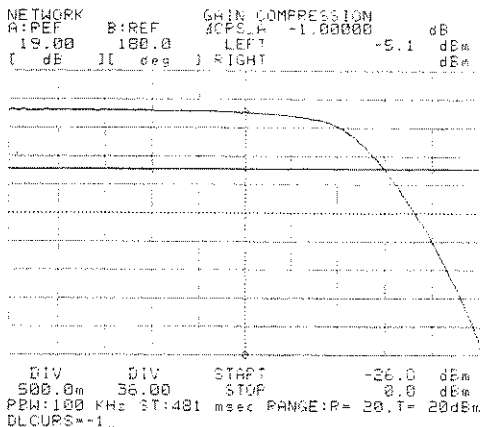

The amplifier's characteristics are shown in the figure on the left. (The figure shows trace A only.) In this measurement, the spot frequency was 10 MHz. The frequency can be changed by pressing the **SWEEP MENU** key to select the **PRMTR** menu and using the **SPOT FREQ** softkey.

The 1 dB gain compression point of the amplifier can be obtained by the following operation sequence.

1. Press the **MODE** key and select the **o MKR&LCUI** softkey.
2. Press the **MKR->MAX** softkey.
3. Set the **Δ mode on/off** softkey to **ON** (on/off).
4. Press the **more** key and select the **Δ VALUE end** softkey. **DCURS=** will appear on the screen, enter the value and the input level at which the gain is reduced by 1 dB can be determined.

Chapter 3

Reflection Measurements with the HP 4195A

Chapter 2 demonstrated how to use the HP 4195A analyzer for transmission measurements. This chapter will describe how to use the HP 4195A to make reflection measurements, another important aspect of network analysis.

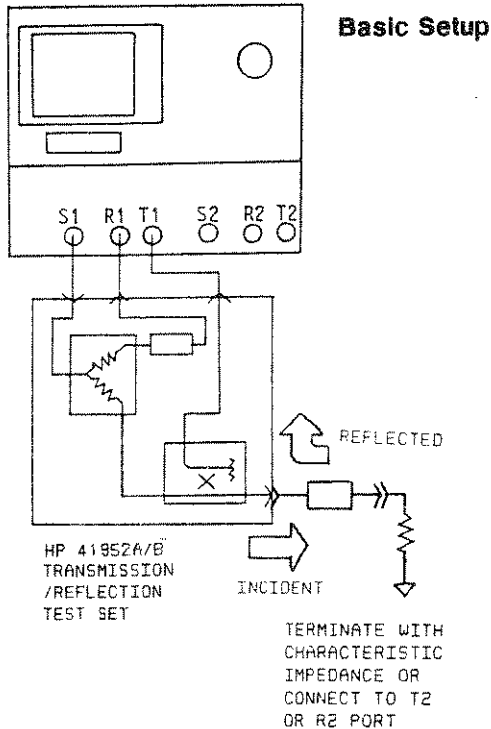

Measuring Return Loss, Reflection Coefficient and SWR

To measure reflection parameters, a directional coupler or bridge is required to pick up the reflected signal. A power splitter is also required to feed the signal to both the reference channel and the directional coupler (bridge). The setup for this measurement is accomplished by connecting the HP 41952A/B Transmission/ Reflection test set as illustrated in the figure at the left. The HP 85044A is used in the measurement examples given in this chapter.

The reflection characteristics of a device is normally measured in the form of return loss, reflection coefficient, and SWR. The relationship between these three factors is as follows.

$$\text{Reflection Coefficient } (\Gamma) = \frac{\text{Reflection Voltage}}{\text{Input Voltage}}$$

$$= S_{11} \text{ (or } S_{22} \text{)} = \rho < \theta$$

(ρ is the absolute value of Γ , and θ is phase angle)

$$\text{Return loss (dB)} = -20 \log (\rho)$$

$$\text{SWR} = \frac{1 + \rho}{1 - \rho}$$

An example of a reflection measurement is given next.

CONFIG S11 of S-PARAMTR

Make sure to select S-parameter S11 with the **CONFIG** key Parameters indicating reflection such as $RL - \theta$, $|\Gamma| - \theta$, $\Gamma_x - \Gamma_y$, $SWR - \theta$ can only be used when S11 or S22 measurements are made.

PRESET Press the **PRESET** key to initialize the analyzer.

CONNECTIONS Connect the HP 41952A as shown in the figure on the left.

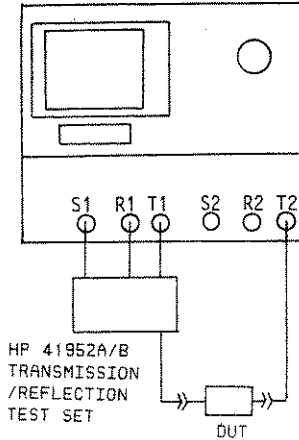

CALIBRATE Perform 1-port Full Calibration as follows. Press the **CAL** key and select the **S-PRMTR CAL** menu softkey. Then press the **ONE PORT FULL CAL** softkey. Connect a **OPEN**, **SHORT** and **50 Ω** standard in sequence to the HP 85044A's test PORT and press the corresponding softkey and the **ENTER/EXECUTE** key. Then press the **RETURN** softkey to display previous softkeys and press the **CONFIRMATION** on/off softkey.

DEVICE UNDER TEST Connect the DUT (a 145 MHz bandpass filter) as shown in the figure and press **TRIG/RST** key.

AUTOSCALE Press the **SCALE REF** key and select the **AUTO SCALE** softkey.

Measuring Return Loss

The figure to the left indicates the return loss for the 145 MHz bandpass filter with previously measured transmission characteristics.

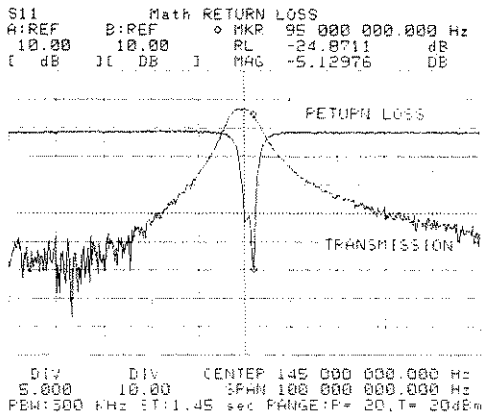

Measuring Reflection coefficient

Press the **FORMAT** key and select the $|\Gamma| - \theta$ softkey start the reflection coefficient measurement.

Measuring SWR

Press the **FORMAT** key and select the **SWR - θ** softkey start the SWR measurement.

Measuring S-Parameters

S-parameters (S11, S21, S12, S22) characterize a two port device. Measurements of S-parameters can be made only by terminating the circuit with a resistor. This facilitates measurements of incident and reflection voltages as the circuit need not be opened or shorted, as in the case of h-parameters. These advantages make them specially suited to measure circuit systems at high frequencies. Each S-parameter can be defined as follows.

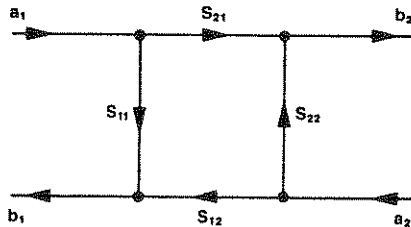

S-parameter	Definition	Significance	Direction	Input
S11	$\frac{b1}{a1} \Big _{a2=0}$	Input reflection coefficient	Forward	T1/R1
S21	$\frac{b2}{a1} \Big _{a2=0}$	Forward Gain (loss)	Forward	T2/R1
S12	$\frac{b1}{a2} \Big _{a1=0}$	Reverse Gain (loss)	Reverse	T1/R2
S22	$\frac{b2}{a2} \Big _{a1=0}$	Output reflection coefficient	Reverse	T2/R2

S11 Measurements

S11 can be measured using the following procedure.

CONFIG

S-PRMTR, S11

PRESET

PRESET key

CONNECTIONS

Connect the HP 41952A as shown in the figure on the left.

CONTROLS

1. FORMAT $\Gamma_x - \Gamma_y$ (When POLAR or SMITH is selected, it is automatically selected.)
2. DISPLAY POLAR
3. SWEEP CENTER 145 MHz
SPAN 10 MHz

CALIBRATE

Perform a 1-port full CAL. Use the same procedure as described in the previous setup. Connect the standards to the left test set.

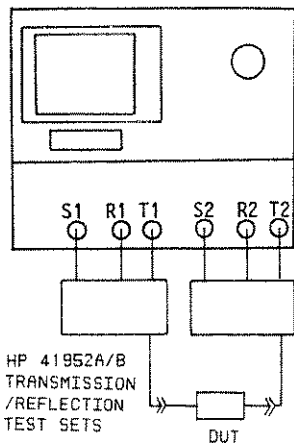

DEVICE UNDER TEST

Connect the DUT (145 MHz bandpass filter) as shown in the figure and press TRIB/RST key.

AUTOSCALE

Press the **SCALE REF** key and select the **AUTO SCALE** softkey. The figure to the left shows a POLAR display of the 145 MHz bandpass filter's S11 characteristics. Each point of the measurement trace indicate the phase and amplitude of the reflection coefficient Γ of the DUT. The display of the reflection coefficient in the center of the POLAR display is 0 which indicates that there is no reflection at all. The outermost circle is $|\Gamma|=1$ which indicates that all of the signal is being reflected back from the device (100% reflection).

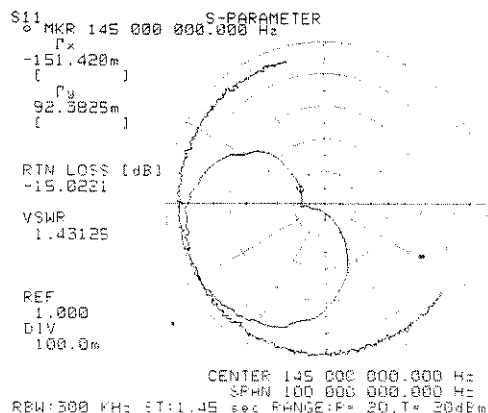

ie
ie
st
re
y
ry
r-

S22/S21/S12 Measurement

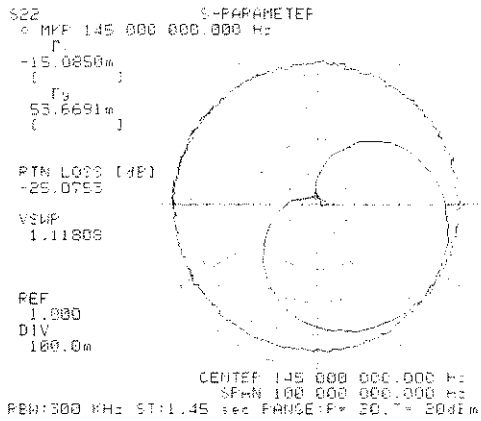

To measure S22, press the **CONFIG** key and select the **S22** softkey. Perform a 1-port full CAL, the same as for the S11 measurement. Connect the standards to the right test set. The characteristics shown in the figure on the left are displayed. Measuring the S21 or S12 can be performed by pressing respective softkey, however it would be necessary to first setup the DUT for a thru connection and then perform a normalize calibration.

ie
ie
et
e
th
vs

Impedance Measurement

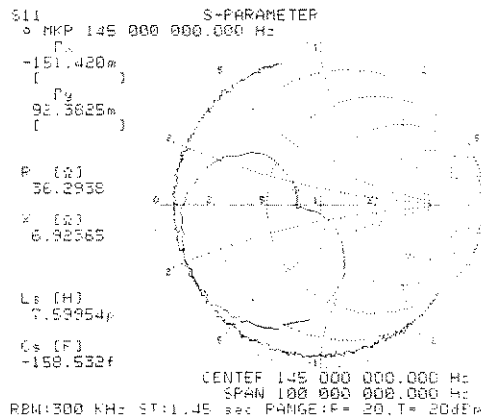

Once the reflection coefficient Γ has been measured, the DUT's impedance is easily determined. Use the same setup as used to measure the S11 and S22 parameters, send the display to Smith chart, then the R-X value, inductance (L) and capacitance (C) can be read from the Smith Chart by using the marker. The figure on the left shows the 145 MHz bandpass filter measured input impedance.

Chapter 4

Spectrum Measurements with the HP 4195A

In chapters 2 and 3 the relationship between input, output, and reflected waveforms were measured using a sine wave, in which only the amplitude or phase differed. In an actual circuit, pure sine waves are seldom realized due to the circuit non-linearity, (i.e. distortion or noise). Non-linear circuits are widely used for modulation and mixing. The HP 4195A's spectrum analysis function is used to measure such non-linearity. This chapter will describe level, distortion and noise measurement using the HP 4195A's spectrum analysis function.

Basic Setup

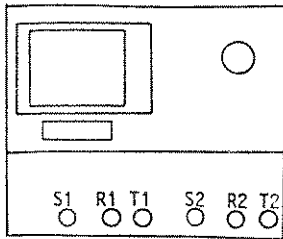

No external test sets are required to perform spectrum measurements. The DUT is connected directly to one of the HP 4195A's four input ports: R1, R2, T1 or T2. An RF amplifier is used for the DUT in the examples. Modify the instrument setups shown to suit the DUT being measured. In the case of measurements involving amplifiers, use an attenuator if the amplifier output exceeds +20 dBm.

Switching Between Input Ports

Press the **CONFIG** key and select the **PORT SELECT** soft-key to switch the HP 4195A's input ports. Then select port R1, T1, R2 or T2.

Level Measurements

The HP 4195A's spectrum function measures the absolute value of the input level. In the following example we will measure an amplifier's output level. The measurement sequence is as follows.

CONFIG SPECTRUM

PRESET Press the **PRESET** key to set the analyzer to an initial state.

CONNECTIONS

Set up as shown in the figure on the left.

CONTROLS

1. **FORMAT** dBm
2. **DISPLAY** rectan X-A&B (Initial state)
3. **SWEEP** CENTER 145 MHz
SPAN 100 MHz

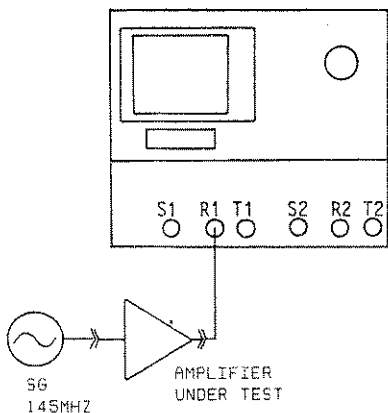

E
e
n
-
ie
of
g
e-
m

AUTOSCALE

Press the **SCALE REF** key and select the **AUTO SCAL** softkey.

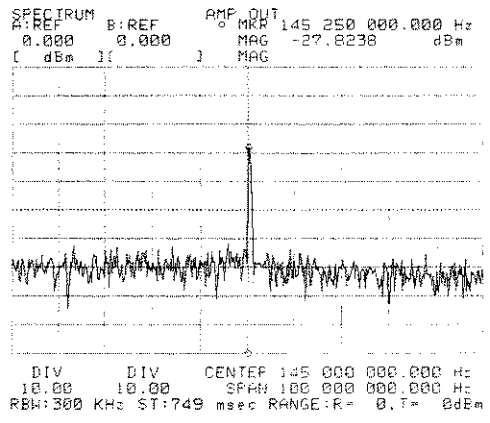

When the measurement results shown in the figure to the left are displayed, press the **MKR→** key and select the **MKR→MAX** softkey. The marker (oMKR) on the trace then moves to the peak point on the displayed trace. The absolute amplitude level (dBm), and the frequency at the marker position are displayed in the upper right corner of the screen. Press the **ATTEN** key of the input port being used to change the setting of the attenuator so the waveform displayed will be measured with the maximum dynamic range.

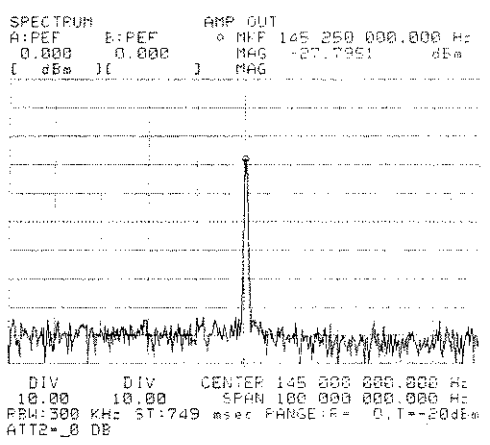

Measuring Noise Level

By using the HP 4195A's noise marker function the spectrum density of the normalized noise at a bandwidth of 1 Hz can be read directly. The measurement is performed as follows:

-
1
is

o
rt

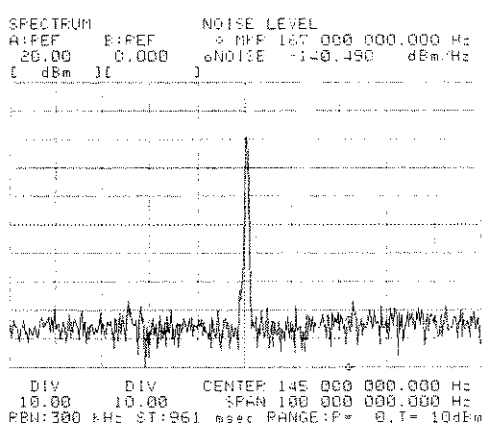

1. Set the marker to the desired frequency.
2. Press the **MKR→** key, and select the **more 1/2** softkey to display the **more 2/2** menu.
3. Set the **NOISE on/off** softkey to **ON (on/off)**, to start reading the noise levels.

Measuring Total Harmonic Distortion

CONFIG SPECTRUM

PRESET Press the **PRESET** key to initialize the HP 4195A.

CONNECTIONS Set up as shown in the figure on the left.

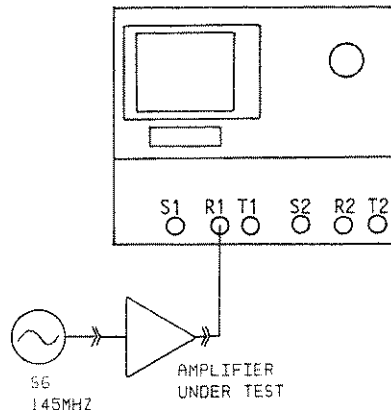

CONTROLS

1. **FORMAT** dBm (Initial state)
2. **DISPLAY** rectan X-A&B (Initial state)
3. **SWEEP** START 100 MHz
STOP 450 MHz

AUTOSCALE

Press the **SCALE REF** key and select the **AUTO SCALE** softkey.

Operate the marker as described in the following sequence.

1. Press the **MKR→** key and select the **MKR→MAX** softkey.
2. Type **R1=MKRA** and press the **ENTER** key. The amplitude value of the fundamental is assigned to variable register R1.
3. Select the **NEXT PEAK** softkey.
4. Type **R2=MKRA** and press the **ENTER** key. The amplitude of the second harmonic is assigned to register R2.
5. Select the **NEXT PEAK** softkey.
6. Type **R3=MKRA** and press the **ENTER** key. The amplitude of the third harmonic is assigned to register R3.
7. Type as follows and press the **ENTER** key.

$$\text{SQR}(10^{**}(\text{R2}-2/20)+10^{**}(\text{R3}-2/20))/10^{**}(\text{R1}/20)*100$$

The ratio of distortion (%) of the second and third harmonic is displayed at the bottom of the screen.

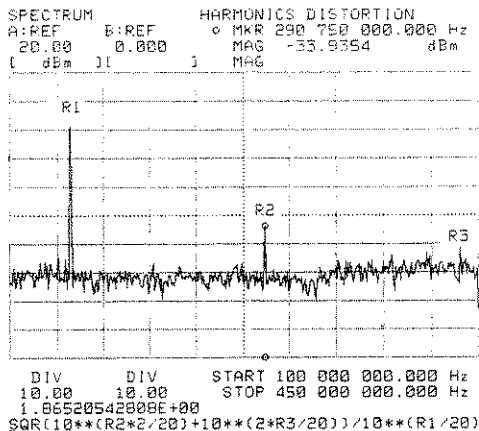

Operations 1 - 7 above can be programmed to be executed by using the user program function. Refer to the example given in APPENDIX B.

Multi-Channel Spectrum Measurement

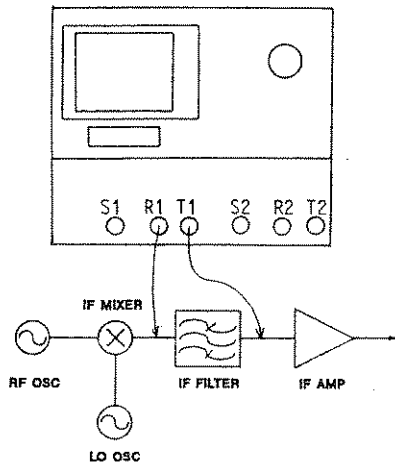

The HP 4195A can switch between the four input ports for spectrum measurements, eliminating the need for reconnecting to different points on a circuit. The HP 4195A can display a maximum of four traces simultaneously. The setup shown on the left permits simultaneous display of two spectrum waveforms.

Proceed as follows.

1. Press the **PRESET** key, the **CONFIG** key, and select the **SPECTRUM** softkey. The measurement result made by R1 port is displayed. R1 Port is selected when the analyzer is initialized.
2. Press the **DISPLAY** key, and set the **TRACE B** on/off softkey to ON (on/off).
3. Type B=A and press the **ENTER** key. The measurement data in register A is transferred to register B, and the result is displayed as trace B (light blue).
4. Press the **CONFIG** key, select the **PORT SELECT** softkey, and press the **T1** softkey to make port T1 the measurement port.
5. The signal input to port T1 is displayed as trace A (yellow). At this time, note that trace B looks like it is being overwritten on every sweep, but actually it maintains the same data.
6. Press the **SCALE REF** key and input the value with the **REF LEVEL** or **/DIV** softkeys or modify the value with the \uparrow and \downarrow keys to display trace A in the top half of the screen. Then press the **SCALE for A/B** softkey and use the same manner to display trace B in the lower half of the screen.

Note: Traces C and D can be used when 3 or 4 trace displays are required. Refer to APPENDIX C, page C-3, for four trace display.

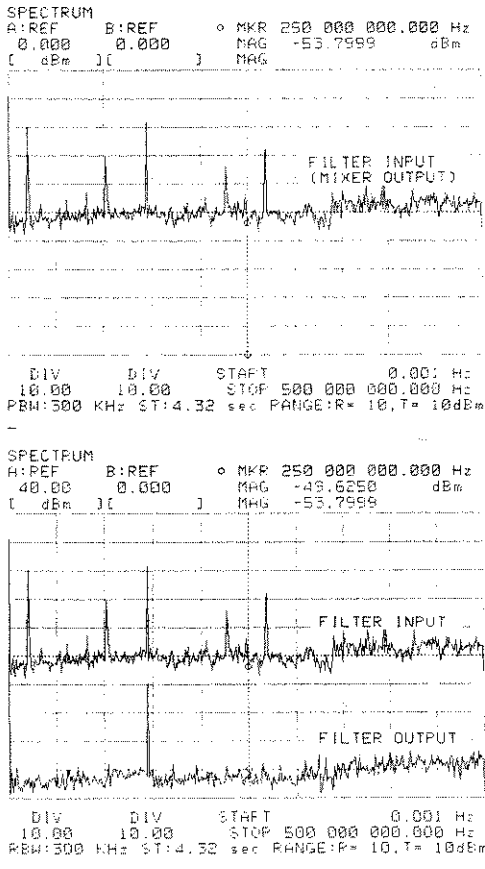

Chapter 5

Impedance Measurements with the HP 4195A

When the HP 41951A impedance test kit is used with the HP 4195A, a devices impedance parameters between 100 kHz and 500 MHz ($|Z|$, $|Y|$, θ , R, X, C, L, Q, D etc.) can be displayed directly. In this chapter, a crystal resonator with a resonant frequency of 80 MHz will be measured.

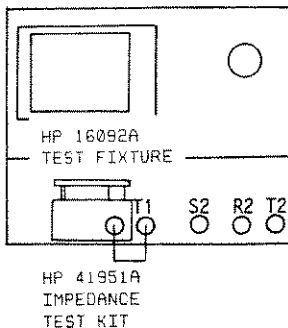

Basic Setup

To perform impedance measurements, the HP 41951A impedance test kit and a test fixture suitable for the DUT are required. The HP 16092A clip test fixture is used in this example.

CONFIG

IMPEDANCE

PRESET

Press the **PRESET** key to initialize the 4195A.

CONNECTIONS

Connect the HP 41951A adaptor as shown in the figure. Do not connect the HP 16092A test fixture.

CONTROLS

1. **FORMAT** $|Z|-\theta$ (Initial state)
2. **DISPLAY** rectan X-A&B (Initial state)
3. **SWEEP** CENTER 80.0014 MHz
SPAN 10 kHz

CALIBRATE

Calibration must be performed to remove measurement errors induced by the 41951A test kit. Perform a 1-port full CAL by connecting 0Ω , $0 S$, 50Ω standards respectively to the 7 mm connector of the Impedance Test Adapter.

COMPENSATION

To obtain the best accuracy, the test fixture residuals should be compensated for. Connect the HP 16092A test fixture and perform OPEN/SHORT offset compensation.

DEVICE UNDER TEST

Connect the DUT to the HP 16092A and press **TRIG/RST** key.

AUTOSCALE

Press the **SCALE REF** key and select the **AUTO SCALE** softkey. The measurement results are displayed as shown in the figure to the left. Trace A displays the absolute value of impedance $|Z|$ and trace B displays the phase angle θ .

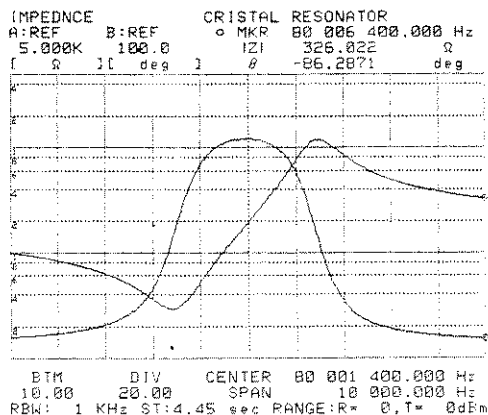

EQUIVALENT CIRCUIT PARAMETER CALCULATION

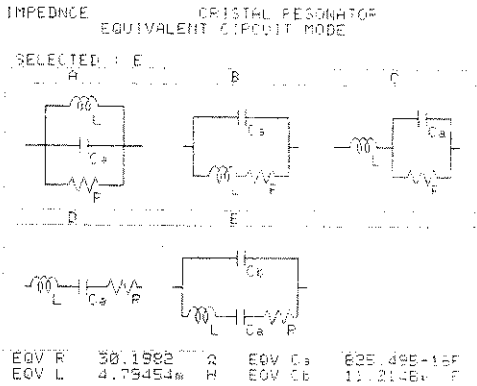

With the equivalent circuit function of the HP 4195A, parameters L, R, C_a and C_b of the crystal resonator's equivalent circuit are automatically calculated by the HP 4195A. The calculation is performed using the measured impedance data.

Proceed as follows to perform the calculation.

1. Press the **MORE** key in the **SPECIAL FUNCTION** section, and select the **EQV CKT** softkey.
2. Press the **CKT E** softkey. (Because the DUT is a crystal. In case of an inductor, select CKT A or B. In case of a capacitor, select CKT D.)
3. When the **CALC EQV para** softkey is pressed, a beep generated to indicate that the equivalent circuit values are displayed in the lower part of the screen (as shown in the figure on the left).

FREQUENCY CHARACTERISTIC SIMULATION

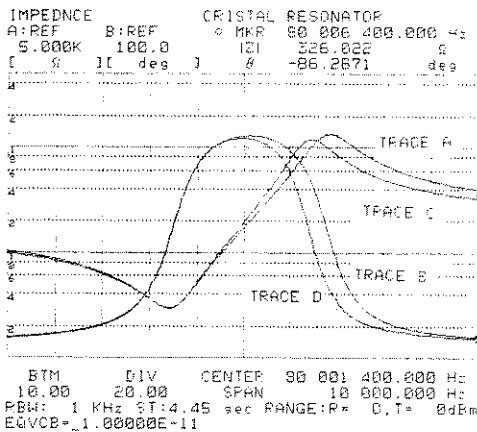

The equivalent circuit analysis function is used to simulate impedance and admittance frequency dependent characteristics. Proceed as follows.

1. Select the **EQV para** entry softkey.
2. Enter the value of each equivalent circuit parameter and press the **return** softkey.
3. When the **SIMULATE f-char** softkey is pressed, the HP 4195A beeps as the simulated frequency characteristics (traces C and D) are displayed with traces A and B (traces C and D display are simulated results, A and B are actual measurements).

Turn off traces A and B to more clearly view traces C and D. To turn off traces A and B, press the **DISPLAY** key and set the **TRACE A on/off** and **TRACE B on/off** softkeys to **OFF** (on/off). To turn off traces C and D, press the **VIEW** key and set the **VIEW C on/off** and **VIEW D on/off** softkeys to **OFF** (on/off).

APPENDIX A

INTERNAL REGISTERS

An HP 4195A "Internal Register" is a memory location to or from which the user can write or read numeric data. By using these registers, the HP 4195A can easily solve various measurement and computational problems. Refer to APPENDIX F for the internal register listing.

Registers Types

The 4195A has the following four types of registers:

	Array Register Contains 401 elements (values)	Single Register Contains only one element (value)
General Purpose Open to users. The HP 4195A will not change the data in these registers.	E - J, RA - RF	R0 - R99
Limited Purpose Opened to users but their application are limited. The HP 4195A may change the data or may be changed by the data in these registers.	Examples: A - D, MA, MB, X ...	Examples MKR, MKRA, CENTER ...

Data Storage

The typical applications for the registers are the storage of measurement data. Array Registers C thru J and RA thru RJ are suitable to this purpose because each of them has a maximum of 401 elements. To store or recall the data, use register operation described below. Also, Example 4) shows an example of storing/recalling the data.

Register Operations

Mathematical operations can be performed using the registers. The syntax for operations is similar to that found in BASIC.

Example)

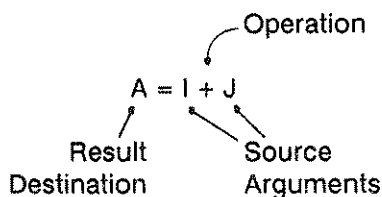

Register operations can be performed from the front panel, in a User Program, in a User Defined Function and in with User Math. During front panel execution, the **ENTER** key should be pressed to execute the operation. Front panel execution is simple, but note that when the SWEEP mode is set to CONT, the data in registers A and B are refreshed during each sweep. The following are examples of array registers operations and marker-related single registers definition.

Example 1) Mathematical Operation

Mathematical operation can be performed for either a) Individual element of array register or b) Entire element of array register.

CONFIG SPECTRUM
 PRESET
 TRIG/RST..... SINGLE mode

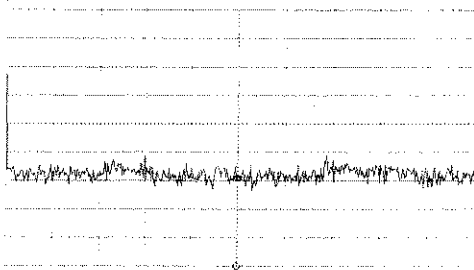

a) Elements within array register can be changed individually.

A(100) = - 15 ENTER

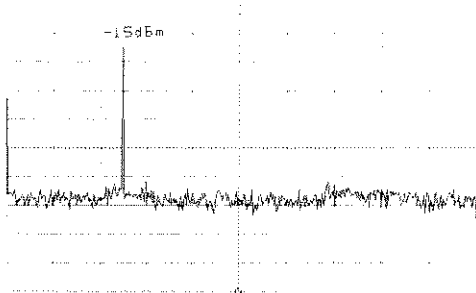

b) Entire register array can be changed very simply.

A = -15 ENTER

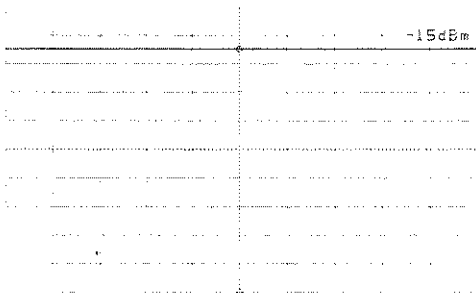

Example 2) Simulation of two filters connected in series

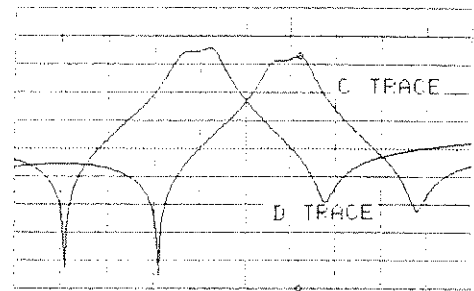

A = C + D ENTER

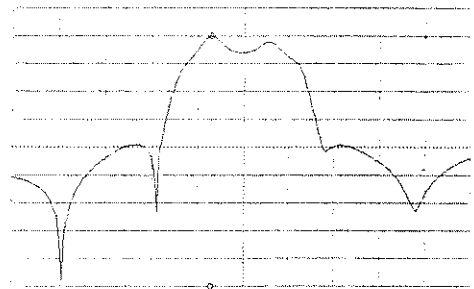

Example 3) Simulation of transmission characteristic of RC filter

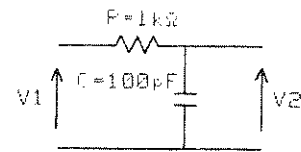

$$T(\omega) = 20 \log \left(\frac{V2}{V1} \right) = 20 \log \left(\frac{1}{\sqrt{1+(\omega RC)^2}} \right)$$

HP 4195A Register Operation:

A=20*LOG(1/SQR(1+(2*PI*X*1E3*1E-10)**2)) ENTER

Where PI: Single Register containing π value
 X: Array register containing freq.values

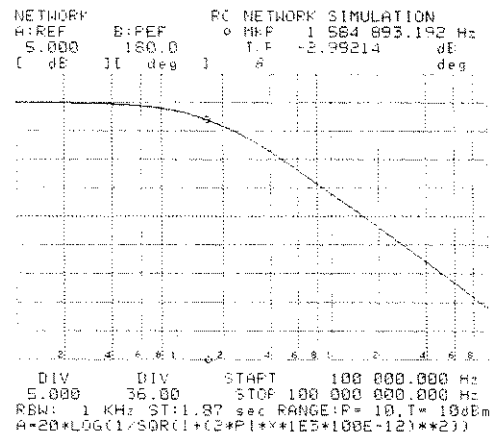

APPENDIX B

USER PROGRAM

User Programs can control almost all HP 4195A functions. These User Programs enable automated measurements, complicated calculations and analysis to be performed quickly and easily. How to write a program, and sample programs are covered next.

How to Write a User Program

Writing User Programs is easy. User programs are created and modified in the "Editor mode". Once you are in the editor, the HP 4195A will automatically generate the command in the program when you push the function keys. You create a User Program in the same way you would perform a manual measurement. The following example is a procedure to write and run a simple program.

Sample Procedure for making and running a program:

Procedure	Key Strokes
1. Scratch the current program	PROGRAM SCRATCH ENTER
2. Select the Editor	EDIT EXECUTE
3. Select Spectrum mode	CONFIG SPECTRUM ENTER
4. Preset	PRESET ENTER
5. Select the input port	PORT SELECT SPECTRUM T1 ENTER
6. Select frequency	START 50MHZ ENTER STOP 250MHZ ENTER
7. Trigger	TRIG/RST ENTER
8. Move the marker to the higher peak	MKR→ oMKR menu MKR→ MAX ENTER
9. End the program	PROGRAM END ENTER
10. Quit the Editor	QUIT EDITOR
11. Run the Program	RUN

Sample Programs

The following programs show typical applications of user Programs. Although the key strokes are not given for these programs, commands are entered by pressing the related keys. Also refer to APPENDIX E where the commands are given with corresponding softkeys.

Example 1) Alternate Transmission/Reflection measurement

This program changes the measurement port for every sweep and is suitable for the measurement setup given on page 3-2.

```
10 FNC1          ! Select Network Measurement
20 RST           ! Preset the 4195A
30 CENTER=145 MHZ ! Set center frequency to 145MHz
40 SPAN=100 MHZ  ! Set span frequency to 100MHz
50 PORT1         ! Select port T1/R1 for reflection measurement
60 SWTRG        ! Initiate a sweep (Sweep Triger)
70 PORT2         ! Select port T2/R1 for transmission measurement
80 SWTRG        ! Initiate a sweep (Sweep Triger)
90 GOTO 50
100 END
```

Example 2) SIN wave, COS wave display

```
10 SWM2          ! Select sweep mode to SINGLE
20 NOP=360       ! Set number of displayed points to 360
30 FOR R0=1 TO 360
40 A(R0)=SIN(R0) ! Substitute SIN value for the R0th element of A register
50 B(R0)=COS(R0) ! Substitute COS value for the R0th element of B register
60 NEXT R0
70 SCL1          ! Scale for A
80 AUTO          ! Autoscale
90 SCL2          ! Scale for B
100 AUTO         ! Autoscale
110 END
```

When you run the program, SIN and COS waves are displayed on the CRT. It will take more than 1 min. to complete this program, because traces A and B are re-written each time as are the A and B registers. The following program shortens the time by using register operations. This program also uses multi-statement technique to shorten execution time and program length.

```
10 SWM2;NOP=360
20 FOR R0=1 TO 360
30 RA(R0)=SIN(R0);RB(R0)=COS(R0)
40 NEXT R0
50 A=RA;B=RB;SCL1;AUTO;SCL2;AUTO
60 END
```

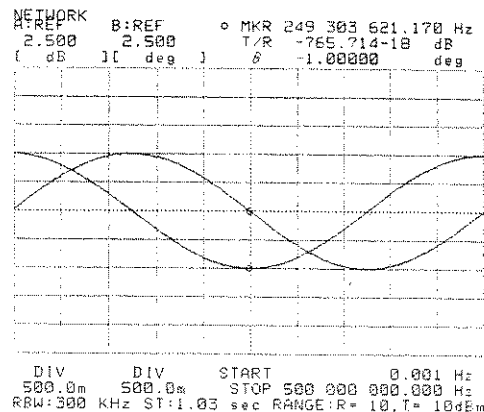

Example 3) 3 dB Bandwidth of the filter

This program measures and displays the 3dB Bandwidth value. Refer to pages 2-1 and 2-2 for measurement sequence.

```
10 FNC1          ! Select Network Measurement
20 RST           ! Preset the 4195A
30 CENTER=145 MHZ;SPAN=100 MHZ
40 SWTRG        ! Initiate a sweep (Sweep Triger)
50 MCF4         ! Select marker and line cursor mode
60 MKMX         ! Marker to MAX
70 DELT1        ! Delta mode ON
80 MKACT0       ! Enable line cursor
90 DLCURS=-3    ! Move line cursor to -3dB down from marker
100 R0=WID      ! Input -3dB bandwidth into R0
110 DISP '3 DB BANDWIDTH (HZ)=' ,R0
120 END
```

Example 4) Total Harmonic Distortion

This program calculates 2nd and 3rd harmonic distortion. Refer to page 4-1 for measurement setup and sequence.

```
10 MCF1         ! Select single marker mode
20 MKMX;R1=MKRA ! Marker to MAX (Fundermantal)
30 NXTPK;R2=MKRA ! Search the next peak (2nd Harmonics)
40 NXTPK;R3=MKRA ! Search the next peak (3rd Harmonics)
50 R0=SQR(10**((2*R2/20)+10**((2*R3/20)))/10**((R1/20)*100
60 DISP 'THD (%)=' ,R0
70 END
```

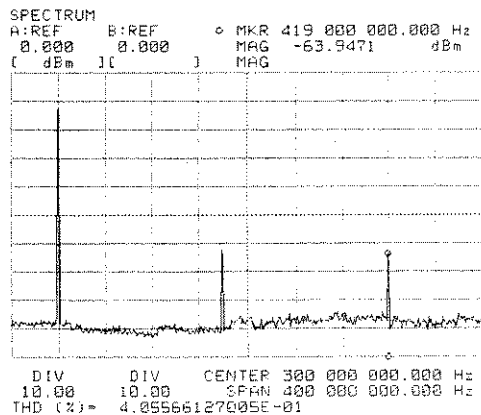

Example 5) Go/No-Go Testing with Limit Line

This program specifies upper/lower limit lines +20 dB apart from the actual measurement value (Line No. 40 ~ 100), and checks if the measured value exceeds the limit (Line No. 120 ~ 240). Decision is made by checking if register B (not displayed), which contains difference between the actual value and limit value, has any negative value (Line No. 130 ~ 160).

```
10 !
20 ! GO/NO-GO WITH LIMIT LINE
30 !
40 FNC1
50 RST
60 CENTER=145 MHZ ;SPAN=50 MHZ;NOP=51;DPB0
70 SWTRG
80 SPSTR;DPA0;AUTO
90 SCL1;R0=REF;R1=DIV;SCL2;REF=R0;DIV=R1
100 C=A+20;D=A-20;DPA1;SPC1;SPD1;MKCR2
110 !
120 SWTRG
130 B=C-A;MKMN
140 IF MKRB<0 THEN GOTO 210
150 B=A-D;MKMN
160 IF MKRB<0 THEN GOTO 210
170 !
180 DISP "PASS"
190 GOTO 120
200 !
210 BEEP
220 DISP "*** FAIL *** PRESS CONT"
230 PAUSE
240 GOTO 120
250 END
```

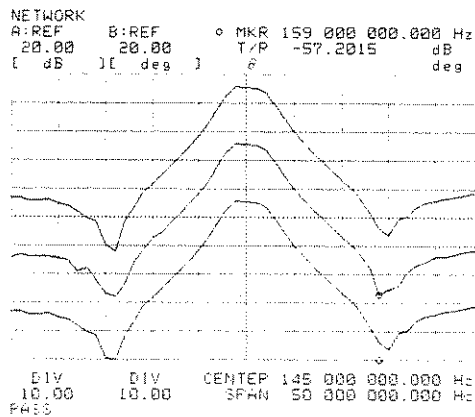

APPENDIX C

USER DEFINED FUNCTION

The HP 4195A's User Defined Function can be used to define a softkey which will perform a sequence of key strokes. This reduces key strokes needed to obtain Total Harmonic Distortion, for instance. Five softkeys can be individually defined. In addition, three **SE** (Sweep End Function) softkeys can be used for operations at the end of every sweep. These **SE** softkeys are used for applications such as Signal Tracking and Alternate Sweep. The following example shows how to define a "3 dB Bandwidth" softkey.

Defining Procedure:

1. Press **USER DEFINED** key.
2. Press the **DEFINE FCTN** softkey.
3. Select the **FCTN1** softkey.

DF1"

will be displayed at the bottom of the CRT.

4. Define a softkey to obtain the -3 dB bandwidth. Refer to page 2-2 for the required key strokes. Each command should be separated by a ";".
5. The following commands should be displayed.

DF1" MCF4;MKMX;DELT1;DLCURS=-3;WIDTH1"

6. Press the **ENTER** key.

Notes:

1. To define **SE** softkeys, press **SWP END FCTN** softkey and then press **DEFINE SE** fctn softkey.
2. Up to 85 characters can be defined for one softkey.
3. The syntax for User Defined Functions is the same as that of a user Program. This means that execution commands such as **RST** and **SWTRG** cannot be used in combination with other commands.

Execution:

Preset the HP 4195A and measure the transmission characteristics of the bandpass filter. Refer to page 2-1 for the measurement procedure. Press the **USER DEFINE** key and the softkey numbered "1". The -3 dB bandwidth is displayed as the **WIDTH** value.

Entering Key Labels:

Any key label (name) can be assigned to a User Defined key. The following procedure shows how to label softkey #1 as "3DB BW".

1. Press the **USER DEFINE** key.
2. Press the **KEL LBL** entry softkey.
3. Select the **fcn 1 KEY LBL** softkey
LBL1"
will be displayed.
4. Input the following using alphanumeric keys
LBL1" 3DB BW"
Up to 15 characters can be used for a label.
5. Press the **ENTER** key.

Examples

Example 1) Filter Parameters

```
DF1 "MCF1;MKMX"  
DF2 "MCF4;MKMX;DELT1;DLCURS=-3;WIDTH1;R2=WID;R0=LCURSL;R1=LCURSR"  
DF3 "MCF2;MKACTION;MKMX;DELT1;MKACTION;DMKR=20 KHZ"  
DF4 "MCF4;MKMX;DELT1;DLCURS=-60;WIDTH1;R3=WID/R2;DISP 'SHAPE FACTOR=',R3"  
DF5 "MCF2;MKR=R0;SMKR=R1;ARSTR;ANA1;LMX(A);ARSTR;MKACTION;MKMX;MKACTION;MKMN;ANA0"
```

```
LBL1 "INSERTN LOSS  "  
LBL2 "3dB      BW"  
LBL3 "OUTBAND REJEC  "  
LBL4 "SHAPE  FACTOR  "  
LBL5 "PASSBANDRIPPLE "
```

Example 2) Signal Track (Application of Sweep End Function)

```
DFA "MKMX;MKCTR"
```

```
LBLA "SIGNAL  TRACK  "
```

Example 3) Alternate Transmission/Reflection Measurement (Application of Sweep End Function)

```
DFA"SPCHG;PORT1;SEFA0;SEFB1"  
DFB"SPCHG;PORT2;SEFB0;SEFA1"
```

Example 4) Four-channel Spectrum Measurement (Defined by User Program)

If the User Defined Functions are defined by a User Program, there are several merits for the user.

- 1) Setup of the 4195A can be made easily.
- 2) User Defined Functions can be stored as an ASP file on the flexible disc. This saves disc space when compared with a STATE file.
- 3) User Program Editor can be used to edit keys.

When you run the following program, instrument setup and key definition are made in one time.

```
10 FNC2  
20 RST  
30 CENTER=145 MHZ ;SPAN=100 MHZ ;DIV=40;SCL2;DIV=40;DPB1;SPC1;SPD1  
100 DF1"PORT1;SCL1;REF=0;C=A-200;DMA=MA;DMB=B;MTHA1;MTHB1;PRMA'R1'"  
110 DF2"PORT2;SCL2;REF=100;D=B-200;DMB=MA;DMA=A;MTHA1;MTHB1;PRMB'T1'"  
120 DF3"PORT3;SCL1;REF=200;C=A+200;DMA=MA;DMB=B;MTHA1;MTHB1;PRMA'R2'"  
130 DF4"PORT4;SCL2;REF=300;D=B+200;DMB=MA;DMA=A;MTHA1;MTHB1;PRMB'T2'"  
140 DF5""  
150 LBL1"R1"  
160 LBL2"T1"  
170 LBL3"R2"  
180 LBL4"T2"  
190 LBL5""  
210 SWM1;UNITA"DBM";UNITB"DBM"  
220 END
```

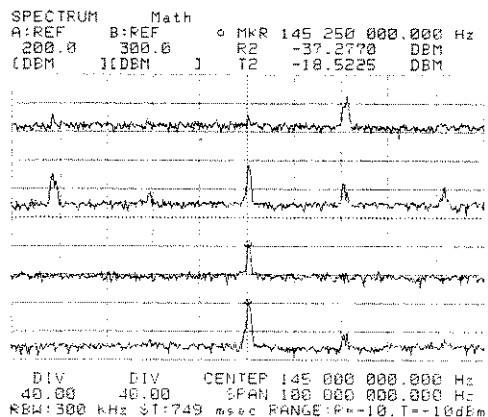

Execution:

Press the **DEFINE MATH** key and set the **MATH->A on/off** softkey to **ON** (on/off). "Math" is displayed on the top line of the CRT and the displayed data is offset by +15 dB.

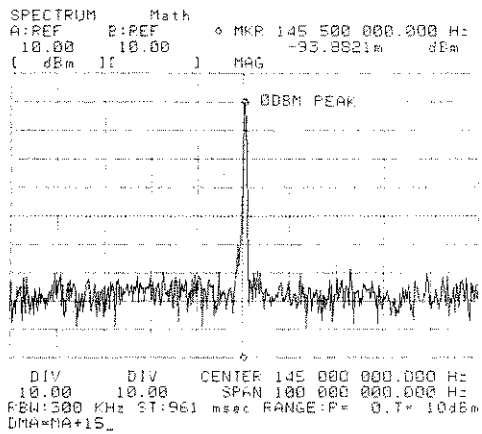

Sample Definitions

Example 1) Max Hold

DMA=MA

DMB=MAX(MA,B)

(Display B ON)

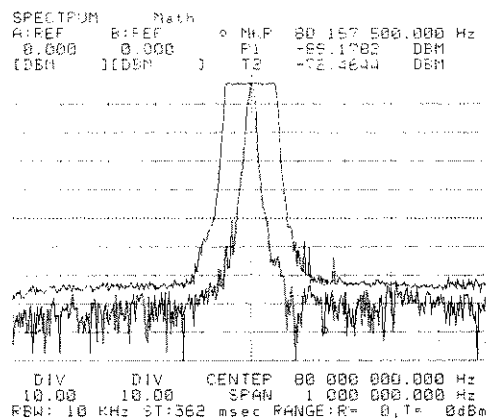

Example 2) Averaging

Averaging 4 times:

DMA=A*3/4+MA/4

Averaging 128 times

DMA=A*127/128+MA/128

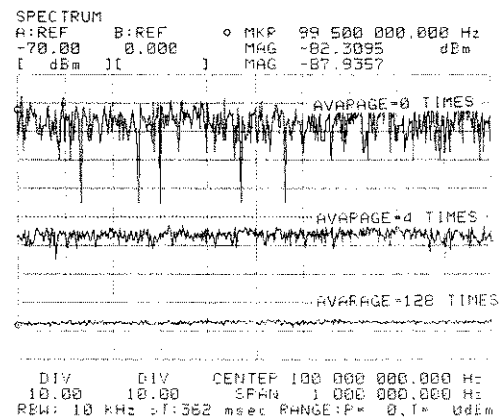

Example 3) 75Ω Environment Measurement

When the HP 4195A is used with an HP 11852B Minimum Loss Pad (5.7 dB Loss) to convert 50 Ω to 75 Ω, it is necessary to set dBm referenced to 75 Ω. Following equation converts measured dBm (in 50 Ω) to dBm in 75 Ω.

$$DMA=MA+5.7$$

Example 4) Vp-p Measurement

While the HP 4195A measures voltage in Vrms, it can be converted into Vp-p using the following equation.

$$DMA= 2\cdot SQR(2)\cdot MA$$

Also unit should be changed as follows.

$$UNITA"Vp-p"$$

APPENDIX E

SOFTKEY TREE

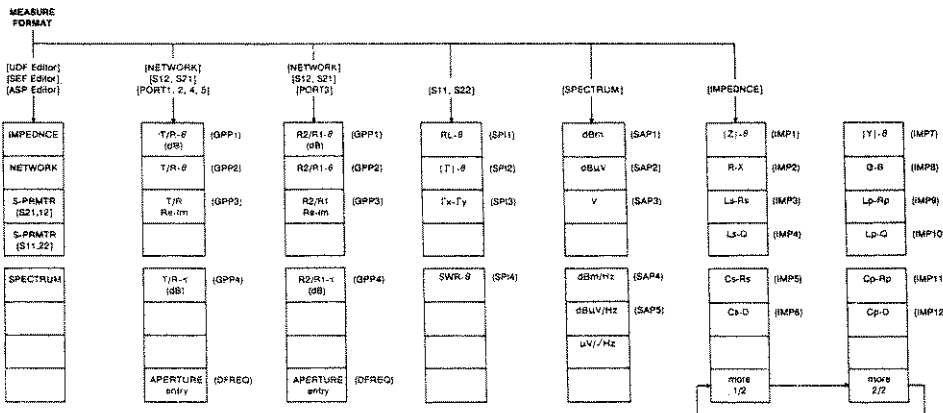
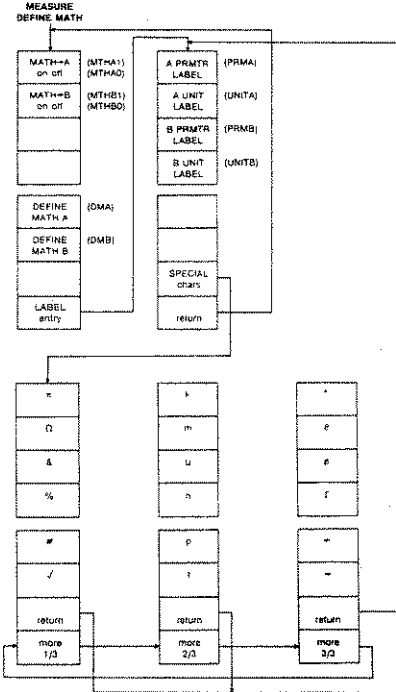
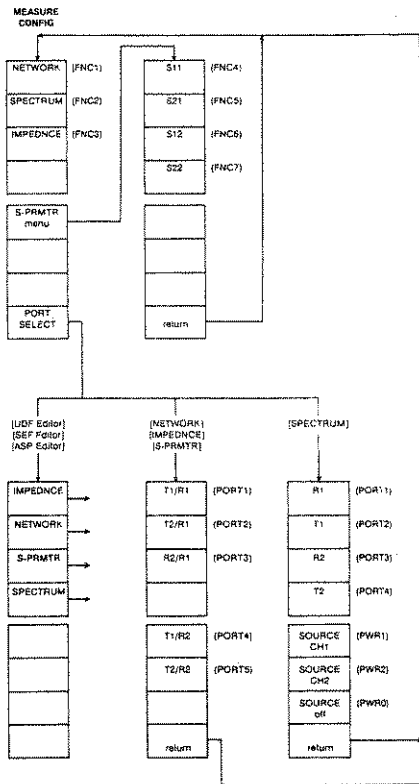
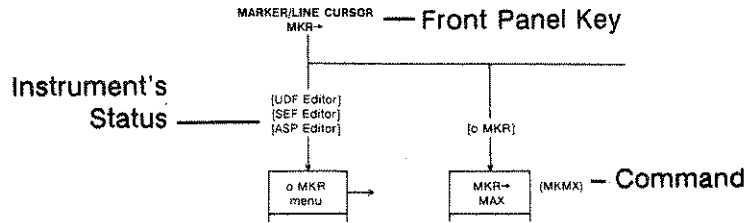

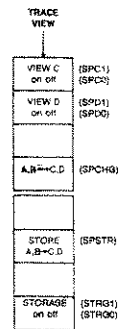
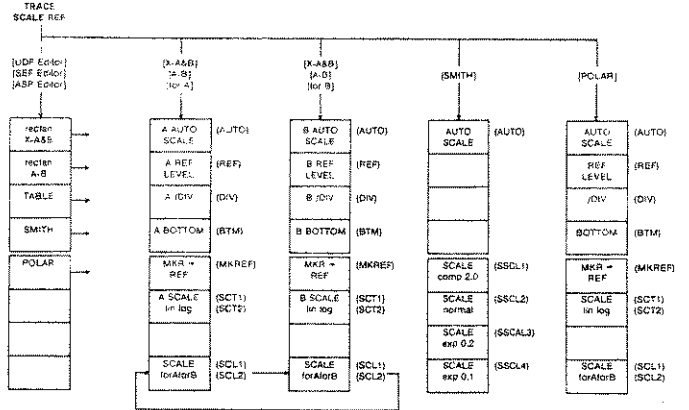
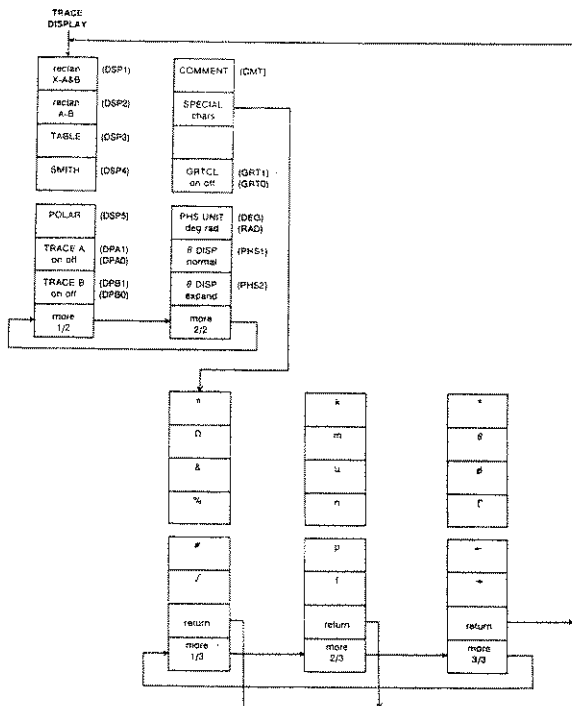
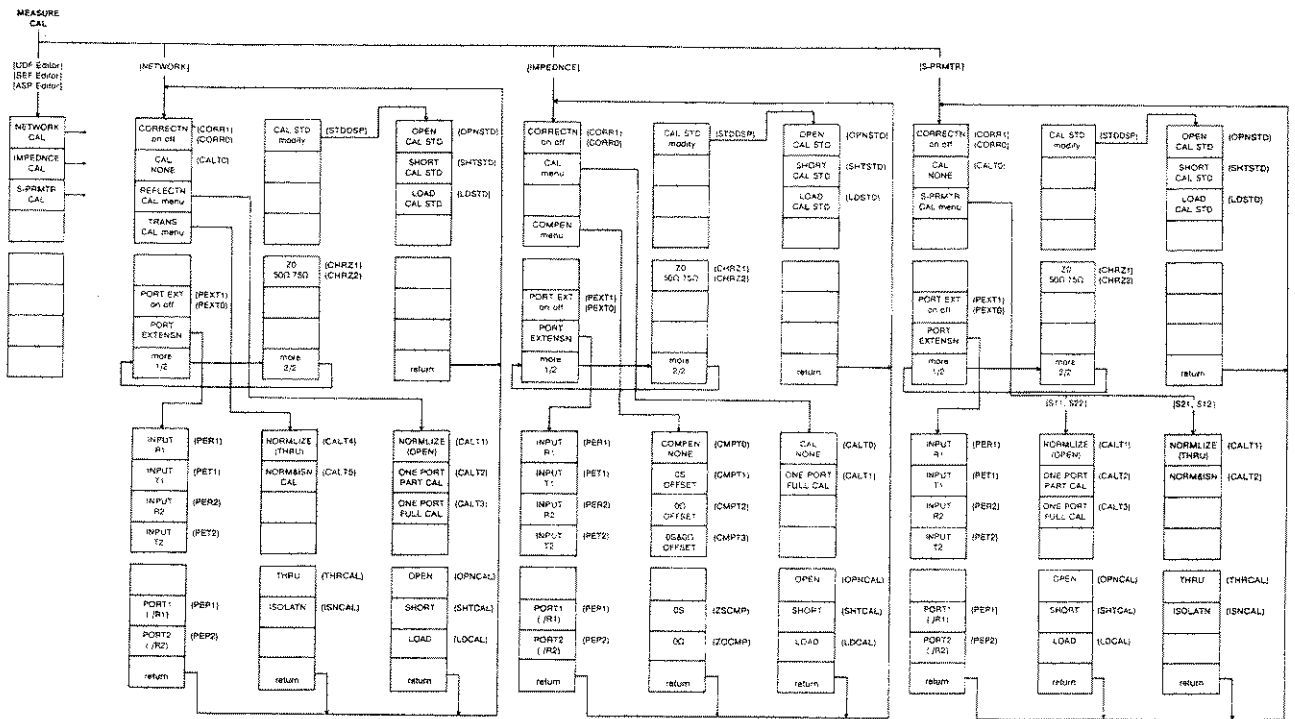

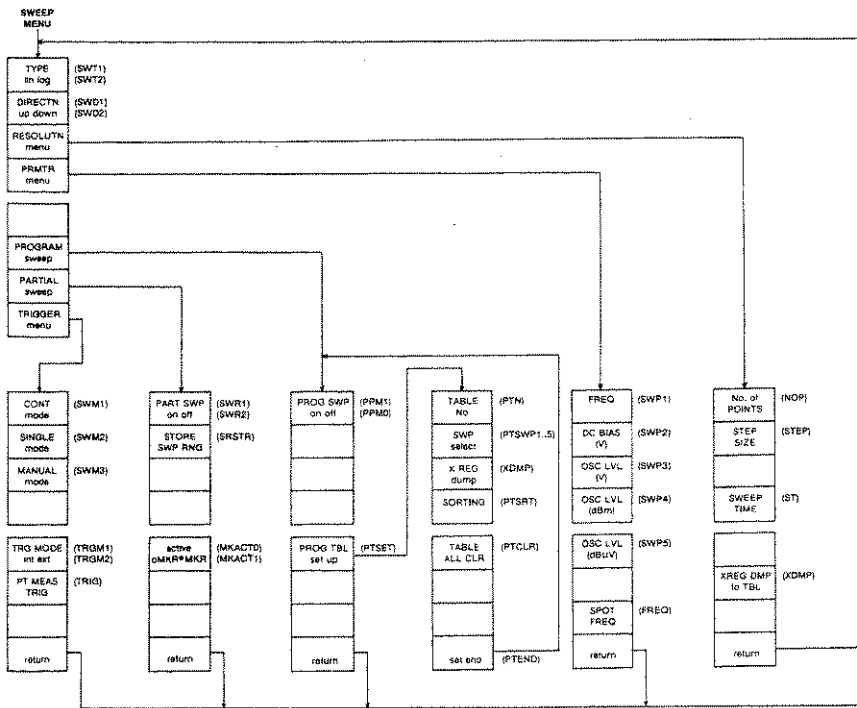

MARKER/LINE CURSOR

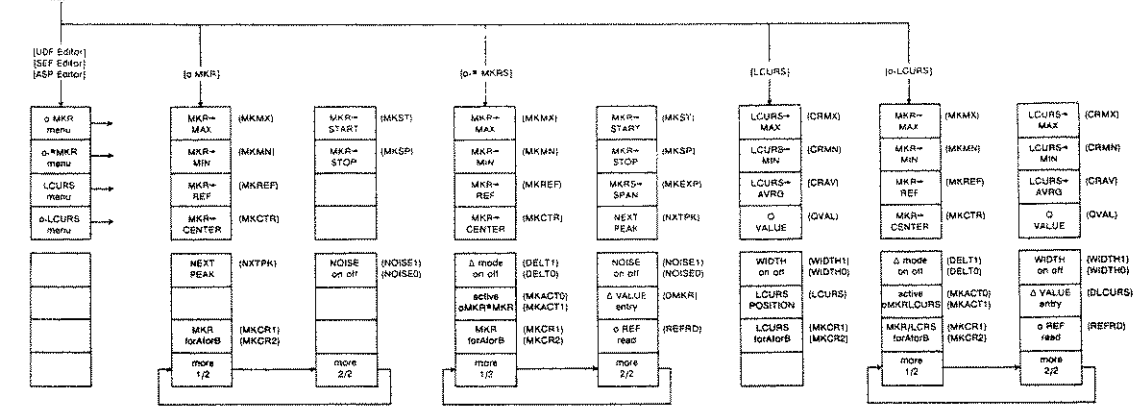

MARKER/LINE CURSOR

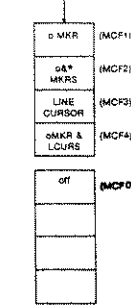

SPECIAL FUNCTION

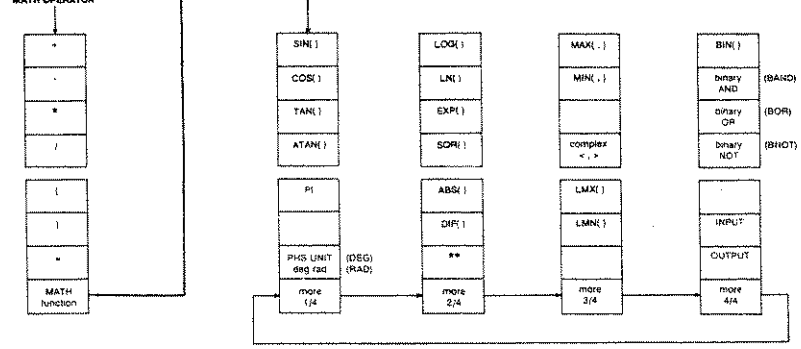

**SPECIAL FUNCTION
USER DEFINE**

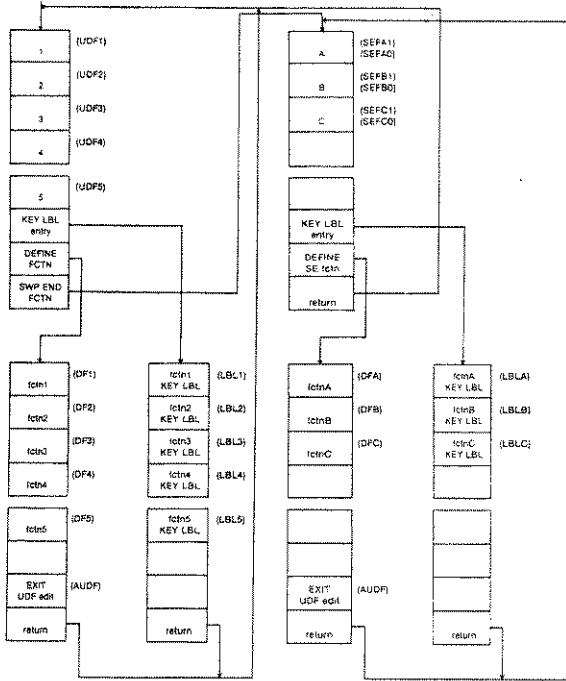

**SPECIAL FUNCTION
SAVE/GET**

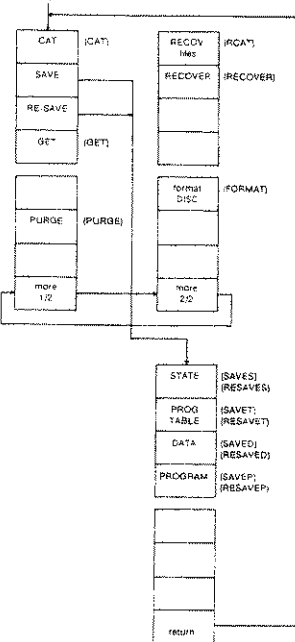

**SPECIAL FUNCTION
COPY**

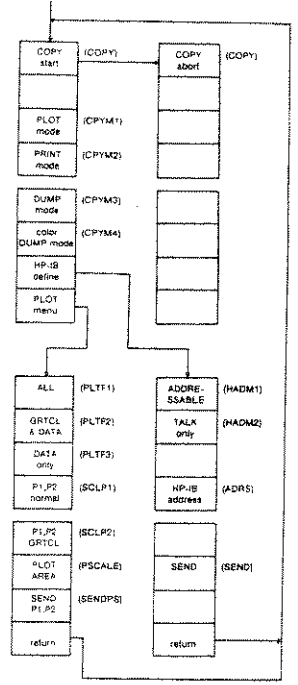

**SPECIAL FUNCTION
PROGRAM**

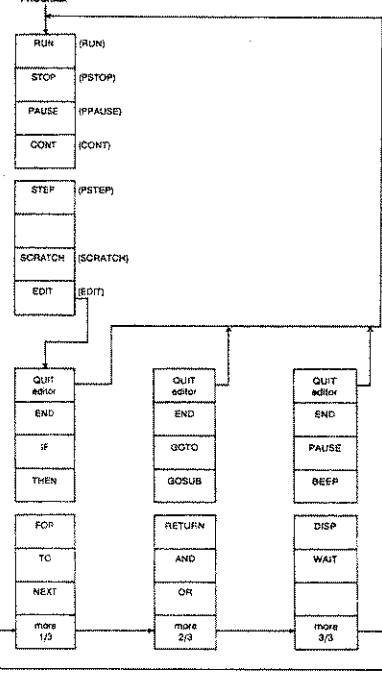

**SPECIAL FUNCTION
MORE**

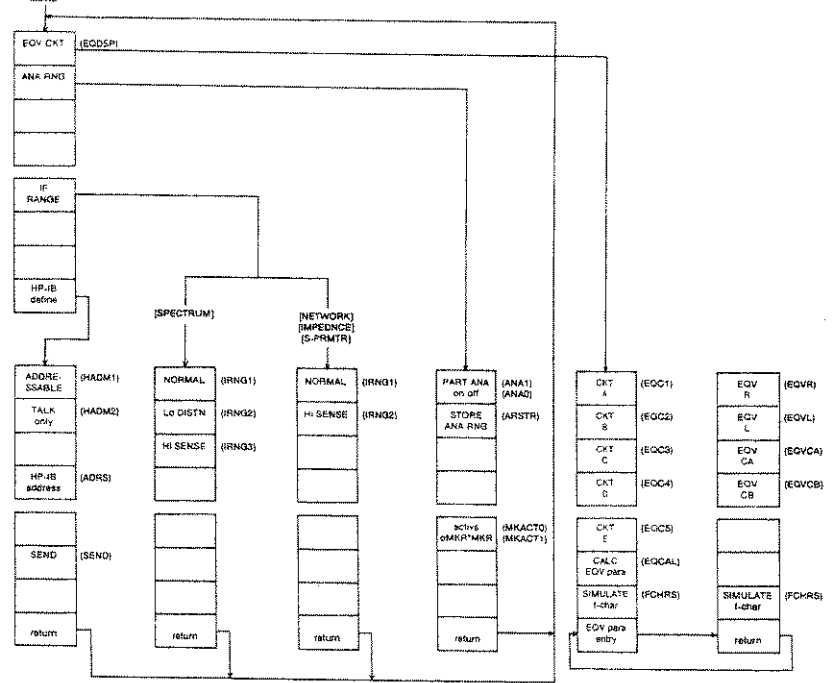

APPENDIX F

INTERNAL REGISTER/COMMAND LISTING

The following are frequently-used registers and commands. This listing does **not** cover all registers and commands used in the HP 4195A. Refer to APPENDIX E for complete listing of softkey-related registers and commands.

ARREY REGISTERS		LCURSL	Contains the value of left most intersect point. Refer to page A-3.
A	Measurement data register displayed on the CRT as a bright yellow trace.	LCURSR	Contains the value of right most intersect point. Refer to page A-3.
B	Measurement data register displayed on the CRT as a bright cyan trace.	MANUAL	Contains manual sweep point value.
C	Superimpose data register. Displayed when View C is set to ON.	MKR	Contains the value of o MARKER position in horizontal axis. Refer to page A-3.
D	Superimpose data register. Displayed when View D is set to ON.	MKRA	Contains data A value specified with the o MARKER. Refer to page A-3.
E - J, RA - RF	General purpose registers.	MKRB	Contains data B value specified with the o MARKER.
MA	Measurement data registers for the User Math Function.	NOP	Contains number of sweep points.
MB	Measurement data registers for the User Math Function.	PI	Contains value of 3.14159265359.
X	Contains the sweep point data.	QV	Contains Q value.
		R0 (- R99)	General purpose single registers.
		RBW	Contains RBW value.
		REF	Contains the top of the display scale.
		SMKR	Contains the value of * MARKER position in vertical axis. Refer to page A-3.
		SMKRA	Contains data B value specified with the * MARKER. Refer to page A-3.
		SMKRB	Contains data B value specified with the * MARKER.
		SPAN	Contains SPAN value.
		START	Contains START value.
		STOP	Contains STOP value.
		WID	Contains width value (=LCURSR-LCURSL). Refer to page A-3.
		Z	Contains numeric value resultant from front-panel mathematical operation.
SINGLE REGISTERS			
ATR1	Contains R1 attenuator value.		
ATR2	Contains R2 attenuator value.		
ATT1	Contains T1 attenuator value.		
ATT2	Contains T2 attenuator value.		
BTM	Contains the bottom of the display scale.		
CENTER	Contains CENTER value.		
DFREQ	Contains APERTURE value.		
DIV	Contains scale division value.		
DLCURS	Contains the difference value between MKRA and LCURS. Refer to page A-3.		
DMKR	Contains the difference value between MKR and SMKR. Refer to page A-3.		
DMKRA	Contains the difference value between MKRA and SMKRA. Refer to page A-3.		
DMKRB	Contains the difference value between MKRB and SMKRB.		
LCURS	Contains the LINE CURSOR position (height) value. Refer to page A-3.		

COMMANDS

ANA1/ANA0	Partial Analysis ON/OFF.	MKCTR	MKR → CENTER
ARSTR	Store Partial Analysis range.	MKEXP	MKRS → SPAN
AUTO	Autoscale to the active scale.	MKMN	MKR → MIN
CMT	Comment.	MKMX	MKR → MAX
COPY	Starts or aborts hardcopy operation.	MKREF	MKR → REF
CORR1/CORR0	Correction ON/OFF.	MKSP	MKR → STOP
DELT1/DELT0	Delta (Δ) mode ON/OFF.	MKST	MKR → START
DF1 (~ DF5)	Defines User Defined Function #1 (~ #5).	MTHA1/MTHA0	Math A ON/OFF.
DFA (~ DFC)	Defines the Sweep End Function #A (~ #C).	MTHB1/MTHB0	Math B ON/OFF.
DISP	Displays a character string, R0 ~ R99 register data or both.	NXTPK	NEXT PEAK.
DMA (DMB)	Defines User Math A (or B) equation.	PORT1 (~ PORT5)	Selects input port.
DPA1/DPA0	Trace A ON/OFF.	PRMA (PRMB)	Enters the User Math A (or B) label.
DPB1/DPB0	Trace B ON/OFF.	RST	PRESET.
DSP1 (~ DSP5)	Selects the rectan X-A&B (or other) display format.	QVAL	Calculates Q value at the LINE CURSOR.
FNC1	Selects the Network configuration.	REV?	Displays the firmware revision code.
FNC2	Selects the Spectrum configuration.	SAP1 (~ SAP6)	Selects dBm (or other) format.
FNC3	Selects the Impedance configuration.	SCL1	Selects the active scale change data to data A (SCALE for A).
FNC4 ~ FNC7	Selects the S-Parameter configuration.	SCL2	Selects the active scale change data to data B (SCALE for B).
GPP1 (~ GPP4)	Selects T/R- θ (or other) format.	SCT1 (SCT2)	Selects the linear (or log) scale display.
HADM1/HADM2	HP-IB Addressable/Talk-only.	SEFA1/SEFA0	Sweep End Function #A ON/OFF.
IMP1 (~ IMP12)	Selects the $ Z $ - θ (or other) format.	SEFB1/SEFB0	Sweep End Function #B ON/OFF.
LBL1 (~ LBL5)	Defines the User Defined Function #1 (~ #5) softkey label.	SEFC1/SEFC0	Sweep End Function #C ON/OFF.
LBLA (~ LBLC)	Defines the Sweep End Function #A (~ #C) softkey label.	SPC1/SPC0	View C ON/OFF.
LMN	Moves the markers to the local-minimum points.	SPCHG	A,B ↔ C,D
LMX	Moves the markers to the local-maximum points.	SPD1/SPD0	View D ON/OFF.
MCF0	Turns MARKER function off.	SPI1 (~ SPI4)	Selects RL- θ (or other) format.
MCF1	Selects the o MARKER mode.	SPSTR	STORE A,B → C,D.
MCF2	Selects the o and * MARKERS mode.	SRSTR	Store Partial Sweep range.
MCF3	Selects the LINE CURSOR mode.	SWM1	CONT sweep mode.
MCF4	Selects the o-LCURS mode.	SWM2	SINGLE sweep mode.
MKACT0	Selects the active marker to * MARKER.	SWM3	MANUAL sweep mode.
MKACT1	Selects the active marker to o MARKER.	SWP1 (~ SWP5)	Selects Frequency (or other) sweep.
MKACT2	Selects the LCURS to active.	SWR1/SWR0	Partial Sweep ON/OFF.
MKCR1	Selects the MARKER or LCURS reading object to data A (for A).	SWT1 (SWT2)	Selects linear (or log) sweep.
MKCR2	Selects the MARKER or LCURS reading object to data B (for B).	SWTRG	Sweep Trigger (=TRIG/RST).
		TRIGM1 (TRIGM2)	Trigger mode int (ext).
		TRIG	Triggers when trigger mode is set to ext.
		UNITA (UNITB)	Enters User Math A (or B) unit label.
		WIDTH1/WIDTH0	WIDTH ON/OFF.
		VFTR1/VFTR0	Video Filter ON/OFF.

REGIONAL SALES AND SUPPORT OFFICES

For information relating to Sales or Support of Hewlett-Packard products first contact your local Hewlett-Packard office listed in the white pages of your telephone directory. If none is listed locally, contact one of the addresses listed below to obtain the address or phone number of the Hewlett-Packard Sales or Support office nearest you.

ASIA

Hewlett-Packard Asia Ltd.
47/F, 26 Harbour Road,
Wanchai, HONG KONG
G.P.O. Box 863, Hong Kong
Tel: (852)5-8330833
Telex: 76793 HPA HX
Cable: HPASIAL TD

AUSTRALASIA

Hewlett-Packard Australia Ltd.
31-41 Joseph Street
BLACKBURN, Victoria 3130
Australia
Tel: (61)895-2895
Telex: 31-024
Cable: HEWPARD Melbourne

CANADA

Hewlett-Packard (Canada) Ltd.
6877 Goreway Drive
MISSISSAUGA, Ontario L4V 1M8
Tel: (416)678-9430
Telex: 069-8644

JAPAN

Yokogawa-Hewlett-Packard Ltd.
29-21 Takaido-Higashi, 3 Chome
Suginami-ku TOKYO 168
Tel: 03(331)6111
Telex: 232-2024 YHPTOK

MEDITERRANEAN AND MIDDLE EAST

Hewlett-Packard S.A.
Mediterranean and Middle East
Operations
Atrina Centre
32 Kifissias Avenue
Paradissos-Amarousion, ATHENS
Greece
Tel: (30)682 88 11
Telex: 21-6588 HPAT GR
Cable: HEWPACKSA Athens

May, 1990

BENELUX & SCANDINAVIA

Hewlett-Packard S.A.
Uilenstede 475
P.O. Box 999
NL-1183 AG AMSTELVEEN
The Netherlands
Tel: (31)20/43 77 71
Telex: 18 919 hpner nl

SOUTH & EAST EUROPE, AFRICA

Hewlett-Packard S.A.
7 rue du Bois-du-Lan
CH-1217 MEYRIN 2, Geneva
Switzerland
Tel: (41)22/83 12 12
Telex: 27835 hmca
Cable: HEWPACKSA Geneva

FRANCE

Hewlett-Packard France
Parc d'activites du Bois Briard
2, avenue du Lac
91040 EVRY Cedex
Tel: 1 6/077 83 83
Telex: 6923 15F

GERMAN FEDERAL REPUBLIC

Hewlett-Packard GmbH
Hewlett-Packard-Strasse
Postfach 1641
D-6380 BAD HOMBURG
West Germany
Tel: 06172/400-0
Telex: 410 844 hpbhg

ITALY

Hewlett-Packard Italiana S.p.A.
Via G. Di Vittorio 9
1-20063 CERNUSCO SUL
NAVIGLIO
(Milano)
Tel: 02/92 36-91
Telex: 334632

UNITED KINGDOM

Hewlett-Packard Ltd.
King Street Lane
Winnersh, WOKINGHAM
Berkshire RG11 5AR
Tel: 734/78/ 47 74
Telex: 847178

EASTERN USA

Hewlett-Packard Co.
4 Choke Cherry Road
ROCKVILLE, MD 20850
TEL: (301)670-4300

MIDWESTERN USA

Hewlett-Packard Co.
5201 Tollview Drive
ROLLING MEADOWS, IL 6008
Tel: (312)255-9800

SOUTHERN USA

Hewlett-Packard Co.
2000 South Park Place
P.O. Box 105005
ATLANTA, GA 30348
Tel: (404)955-1500

WESTERN USA

Hewlett-Packard Co.
5161 Lankershim Blvd.
P.O. Box 3919
NO. HOLLYWOOD, CA 91609
Tel: (818)506-3700

OTHER INTERNATIONAL AREAS

Hewlett-Packard Co.
Intercontinental Headquarters
3495 Deer Creek Road
PALO ALTO, CA 94304
Tel: (415)857-1501
Telex: 034-8300
Cable: HEWPACK

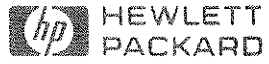

HEWLETT
PACKARD

Reorder No. or
Manual Part No.
5950-2942

Copyright © 1988
Hewlett-Packard
Printed in Japan

Manufacturing
Part No.
5950-2942



5950-2942